

City of Madison

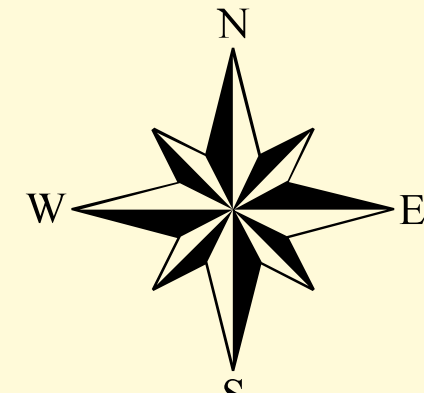

0 0.125 0.25 0.5 0.75 1
Miles

1 inch = 969 feet

- Chip East
- Chip West
- Basket inlets required

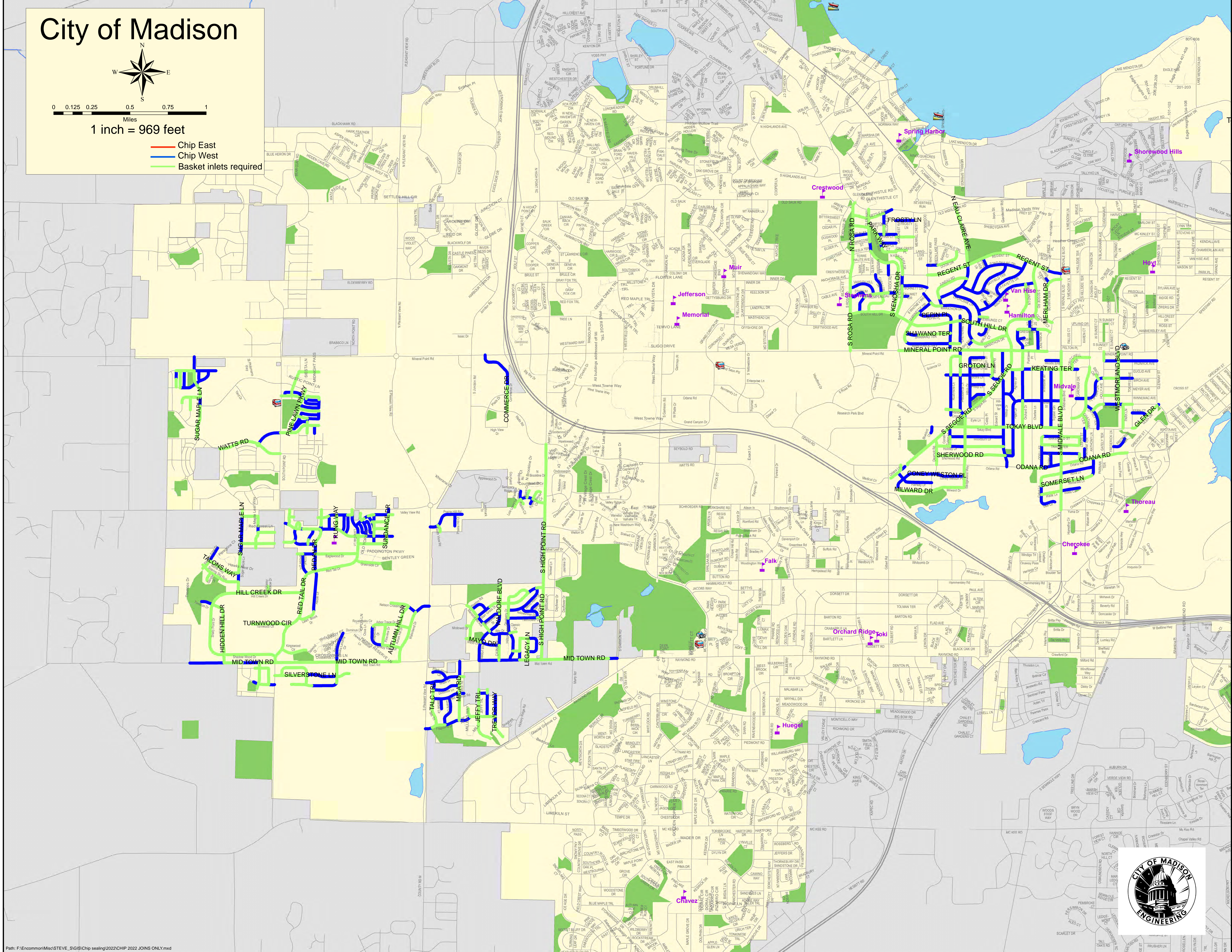

City of Madison



0 0.125 0.25 0.5 0.75 1
Miles

1 inch = 969 feet

- Chip East
- Chip West
- Basket inlets required

- All-day service bus route streets
- Peak hour service bus route streets
- Bus parking layover



SCALE: 1" = 60'

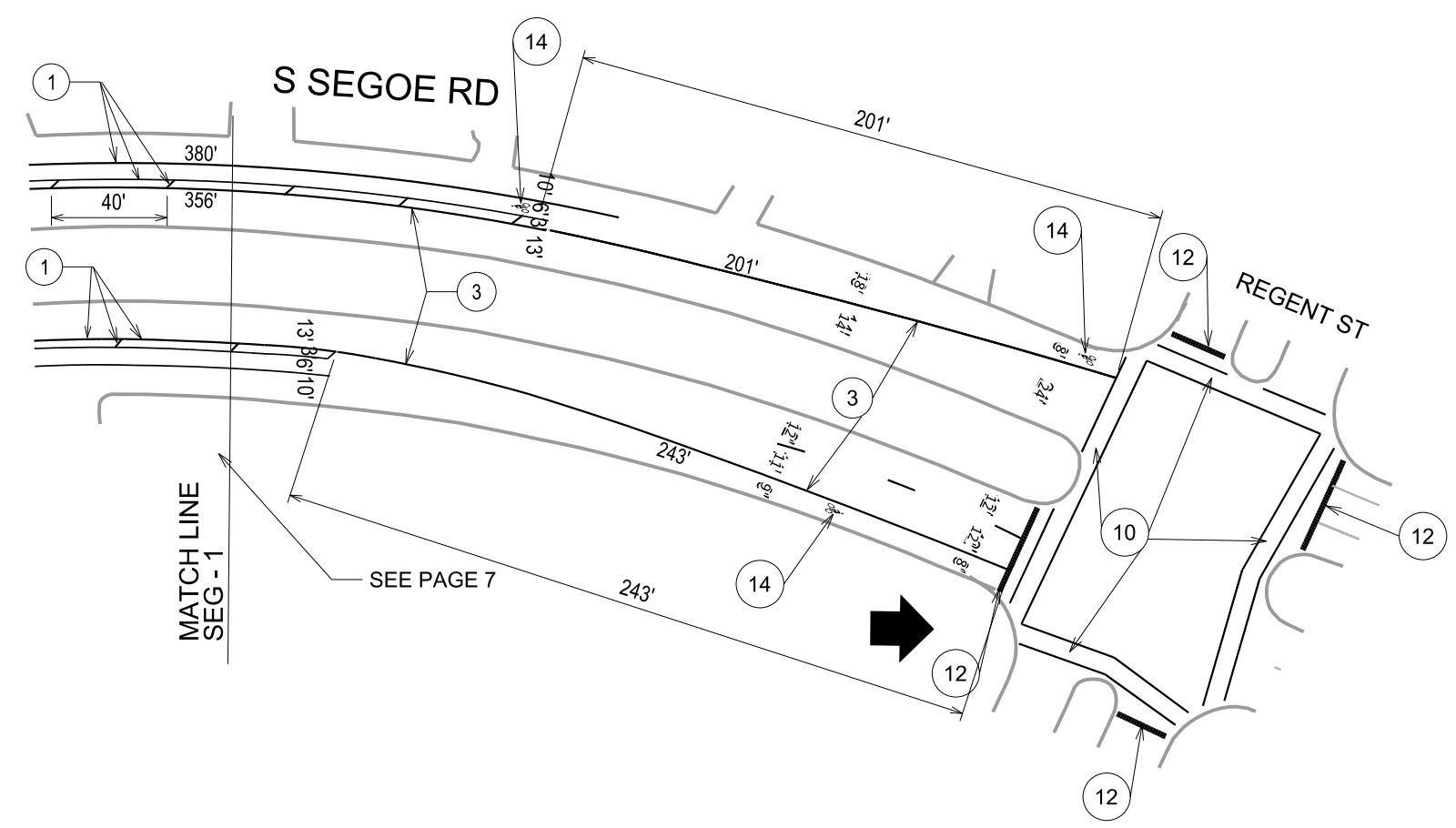

Callout	Bid Item	Description
1	60800	Pavement Marking Epoxy, 4-Inch, Solid White
2	60801	Pavement Marking Epoxy, 4-Inch Double Yellow
3	60802	Pavement Marking Epoxy, 6-Inch Solid White
4	60802	Pavement Marking Epoxy, 6-Inch White Skips, (10' Line, 30' Gap)
5	60802	Pavement Marking Epoxy, 6-Inch Yellow Skips (10' Line, 30' Gap)
6	60802	Pavement Marking Epoxy, 6-Inch White Skips, (2' Line, 6' Gap)
7	60803	Pavement Marking Epoxy, 8-Inch Solid White
8	60803	Pavement Marking Epoxy, 8-Inch White Skips, (5' Line, 5' Gap)
9	60803	Pavement Marking Epoxy, 8-Inch White Skips, (2' Line, 6' Gap)
10	60812	Pavement Marking Epoxy, 6-Inch White, Crosswalk
11	60815	Pavement Marking Epoxy, Continental Crosswalk, 18-Inch
12	60818	Pavement Marking Epoxy, 24-Inch White, Stop Line
13	60822	Pavement Marking Epoxy, Symbol, Bike Sharrow
14	60823	Pavement Marking Epoxy, Symbol, Bike Lane
15	60824	Pavement Marking Epoxy, Symbol, Bike Straight Arrow
16	60829	Pavement Marking Epoxy, Symbol, Left Arrow
17	60830	Pavement Marking Epoxy, Symbol, Right Arrow
18	60834	Pavement Marking Epoxy, Word, "ONLY"

PLOT SCALE:

PLOT NAME:

REV. DATE:

ORIGINATOR: CITY OF MADISON, TRAFFIC ENG. DIV.

SCALE: 1" = 60'

Callout	Bid Item	Description
1	60800	Pavement Marking Epoxy, 4-Inch, Solid White
2	60801	Pavement Marking Epoxy, 4-Inch Double Yellow
3	60802	Pavement Marking Epoxy, 6-Inch Solid White
4	60802	Pavement Marking Epoxy, 6-Inch White Skips, (10' Line, 30' Gap)
5	60802	Pavement Marking Epoxy, 6-Inch Yellow Skips (10' Line, 30' Gap)
6	60802	Pavement Marking Epoxy, 6-Inch White Skips, (2' Line, 6' Gap)
7	60803	Pavement Marking Epoxy, 8-Inch Solid White
8	60803	Pavement Marking Epoxy, 8-Inch White Skips, (5' Line, 5' Gap)
9	60803	Pavement Marking Epoxy, 8-Inch White Skips, (2' Line, 6' Gap)
10	60812	Pavement Marking Epoxy, 6-Inch White, Crosswalk
11	60815	Pavement Marking Epoxy, Continental Crosswalk, 18-Inch
12	60818	Pavement Marking Epoxy, 24-Inch White, Stop Line
13	60822	Pavement Marking Epoxy, Symbol, Bike Sharrow
14	60823	Pavement Marking Epoxy, Symbol, Bike Lane
15	60824	Pavement Marking Epoxy, Symbol, Bike Straight Arrow
16	60829	Pavement Marking Epoxy, Symbol, Left Arrow
17	60830	Pavement Marking Epoxy, Symbol, Right Arrow
18	60834	Pavement Marking Epoxy, Word, "ONLY"

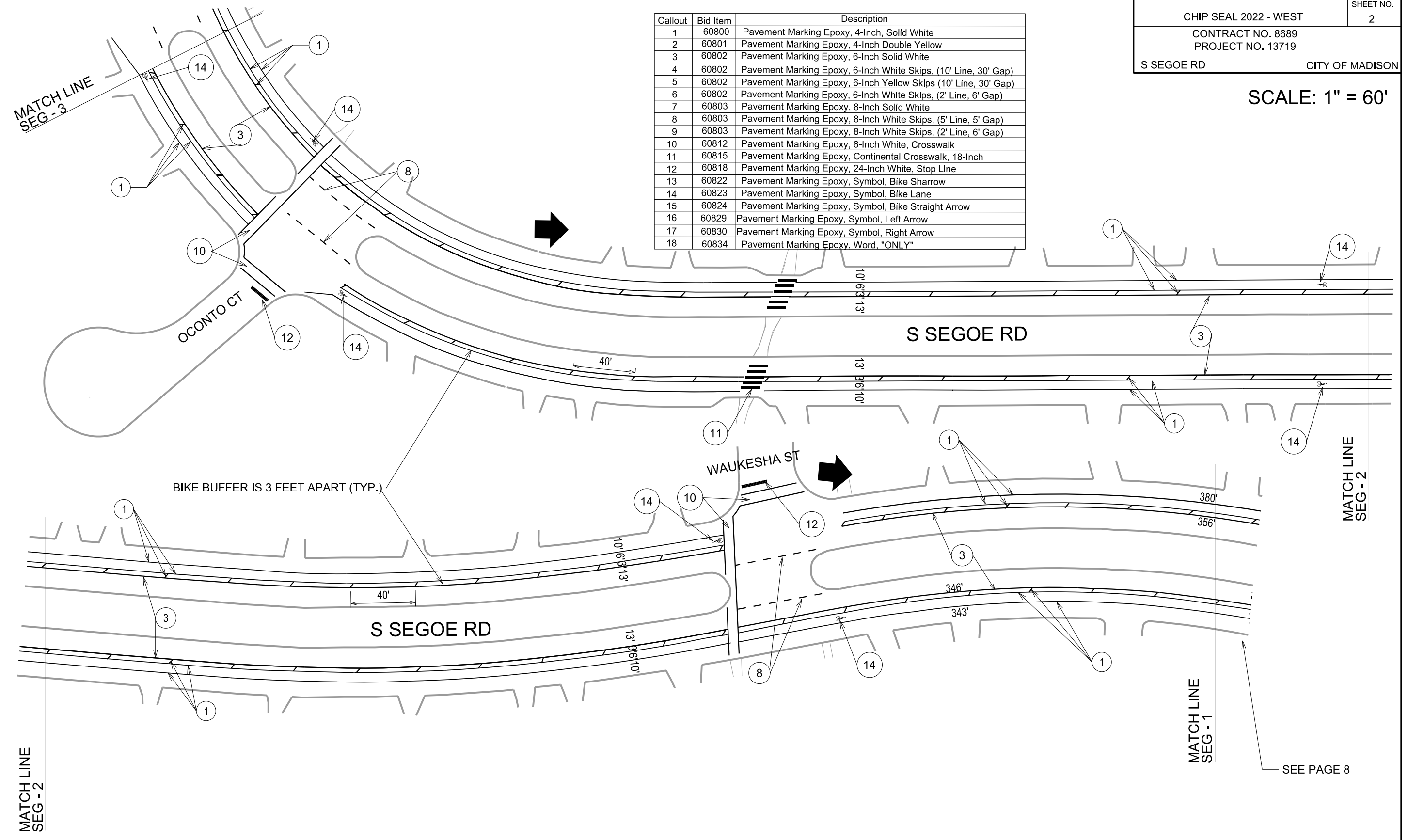

SEE PAGE 8

PLOT SCALE:
 PLOT NAME:
 REV. DATE:
 ORIGINATOR: CITY OF MADISON, TRAFFIC ENG. DIV.

SCALE: 1" = 60'

Callout	Bid Item	Description
1	60800	Pavement Marking Epoxy, 4-Inch, Solid White
2	60801	Pavement Marking Epoxy, 4-Inch Double Yellow
3	60802	Pavement Marking Epoxy, 6-Inch Solid White
4	60802	Pavement Marking Epoxy, 6-Inch White Skips, (10' Line, 30' Gap)
5	60802	Pavement Marking Epoxy, 6-Inch Yellow Skips (10' Line, 30' Gap)
6	60802	Pavement Marking Epoxy, 6-Inch White Skips, (2' Line, 6' Gap)
7	60803	Pavement Marking Epoxy, 8-Inch Solid White
8	60803	Pavement Marking Epoxy, 8-Inch White Skips, (5' Line, 5' Gap)
9	60803	Pavement Marking Epoxy, 8-Inch White Skips, (2' Line, 6' Gap)
10	60812	Pavement Marking Epoxy, 6-Inch White, Crosswalk
11	60815	Pavement Marking Epoxy, Continental Crosswalk, 18-Inch
12	60818	Pavement Marking Epoxy, 24-Inch White, Stop Line
13	60822	Pavement Marking Epoxy, Symbol, Bike Sharrow
14	60823	Pavement Marking Epoxy, Symbol, Bike Lane
15	60824	Pavement Marking Epoxy, Symbol, Bike Straight Arrow
16	60829	Pavement Marking Epoxy, Symbol, Left Arrow
17	60830	Pavement Marking Epoxy, Symbol, Right Arrow
18	60834	Pavement Marking Epoxy, Word, "ONLY"
19	60814	Pavement Marking Epoxy, 12-Inch White, Crosswalk

SEE ALSO
PAGE 4 - SEGOE RD
PAGE 15 - MINERAL POINT RD

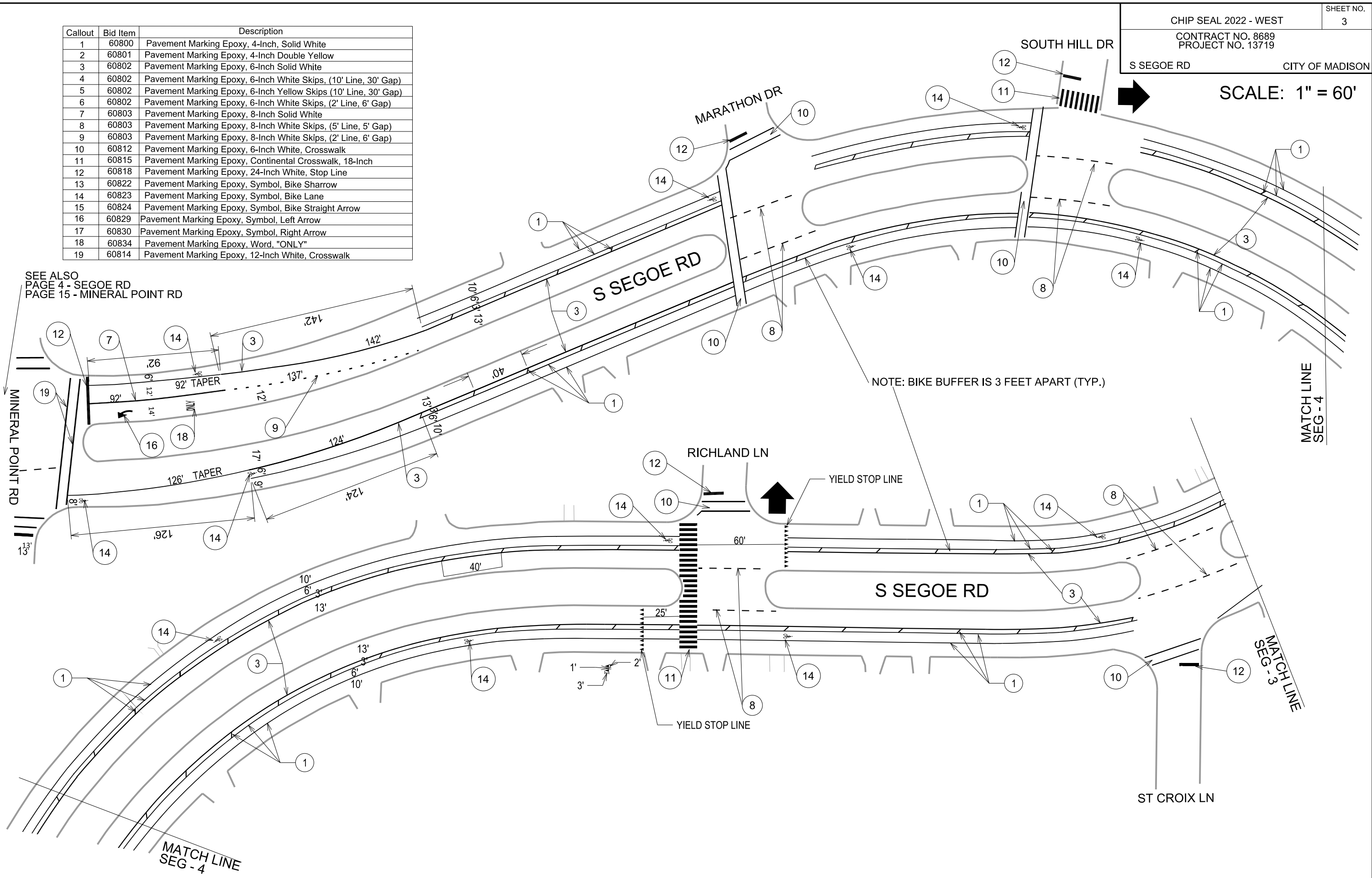

NOTE: BIKE BUFFER IS 3 FEET APART (TYP.)

PLOT SCALE:

PLOT NAME:

REV. DATE:

ORIGINATOR: CITY OF MADISON, TRAFFIC ENG. DIV.

SEE ALSO
 PAGE 3 - S EGOE RD
 PAGE 15 - MINERAL POINT RD

Callout	Bid Item	Description
1	60800	Pavement Marking Epoxy, 4-Inch, Solid White
2	60801	Pavement Marking Epoxy, 4-Inch Double Yellow
3	60802	Pavement Marking Epoxy, 6-Inch Solid White
4	60802	Pavement Marking Epoxy, 6-Inch White Skips, (10' Line, 30' Gap)
5	60802	Pavement Marking Epoxy, 6-Inch Yellow Skips (10' Line, 30' Gap)
6	60802	Pavement Marking Epoxy, 6-Inch White Skips, (2' Line, 6' Gap)
7	60803	Pavement Marking Epoxy, 8-Inch Solid White
8	60803	Pavement Marking Epoxy, 8-Inch White Skips, (5' Line, 5' Gap)
9	60803	Pavement Marking Epoxy, 8-Inch White Skips, (2' Line, 6' Gap)
10	60812	Pavement Marking Epoxy, 6-Inch White, Crosswalk
11	60815	Pavement Marking Epoxy, Continental Crosswalk, 18-Inch
12	60818	Pavement Marking Epoxy, 24-Inch White, Stop Line
13	60822	Pavement Marking Epoxy, Symbol, Bike Sharrow
14	60823	Pavement Marking Epoxy, Symbol, Bike Lane
15	60824	Pavement Marking Epoxy, Symbol, Bike Straight Arrow
16	60829	Pavement Marking Epoxy, Symbol, Left Arrow
17	60830	Pavement Marking Epoxy, Symbol, Right Arrow
18	60834	Pavement Marking Epoxy, Word, "ONLY"
19	60814	Pavement Marking Epoxy, 12-Inch White, Crosswalk

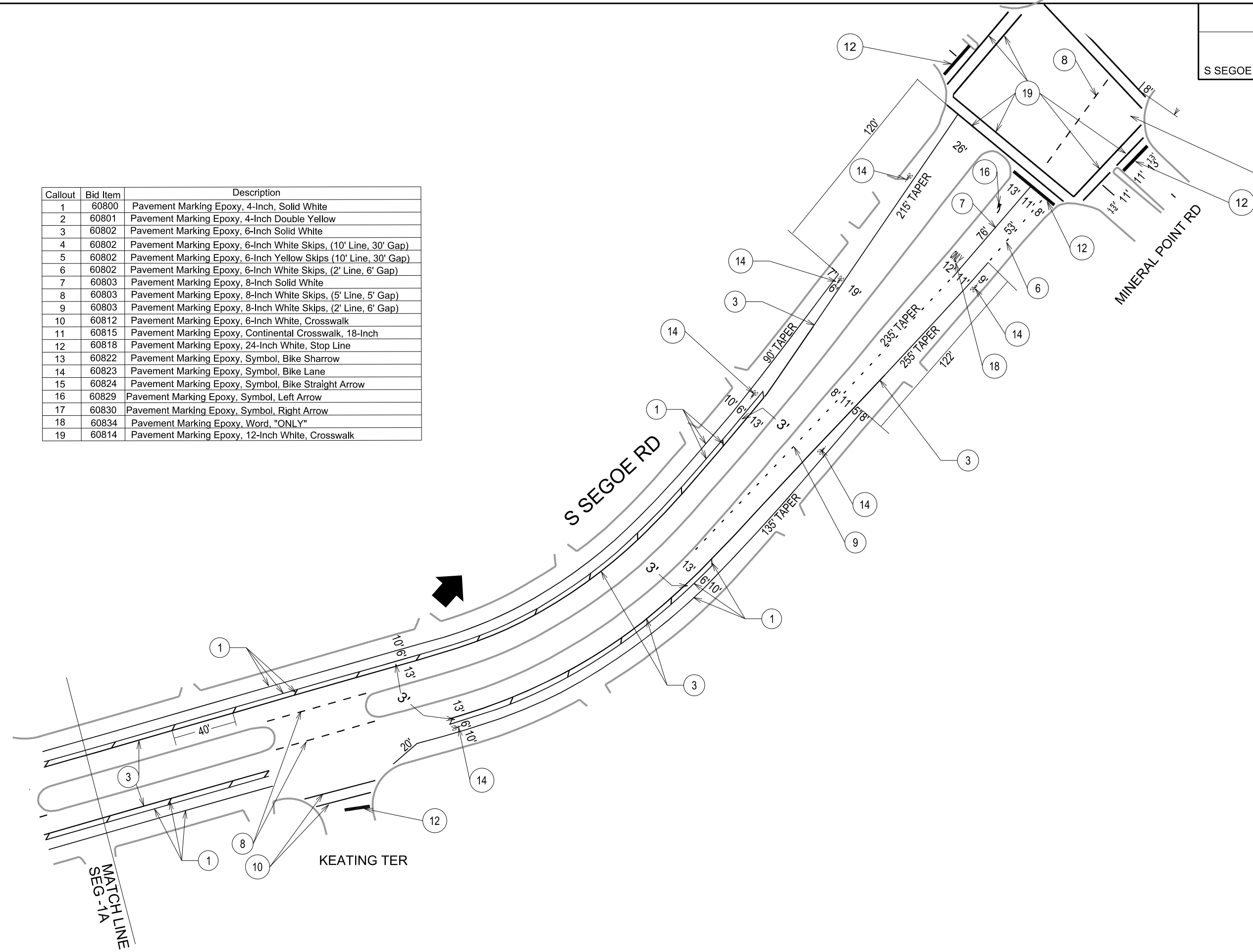

PLOT SCALE:

PLOT NAME:

REV. DATE:

ORIGINATOR: CITY OF MADISON, TRAFFIC ENG. DIV.

PLOT SCALE:
PLOT NAME:
REV. DATE:
ORIGINATOR: CITY OF MADISON, TRAFFIC ENG. DIV.

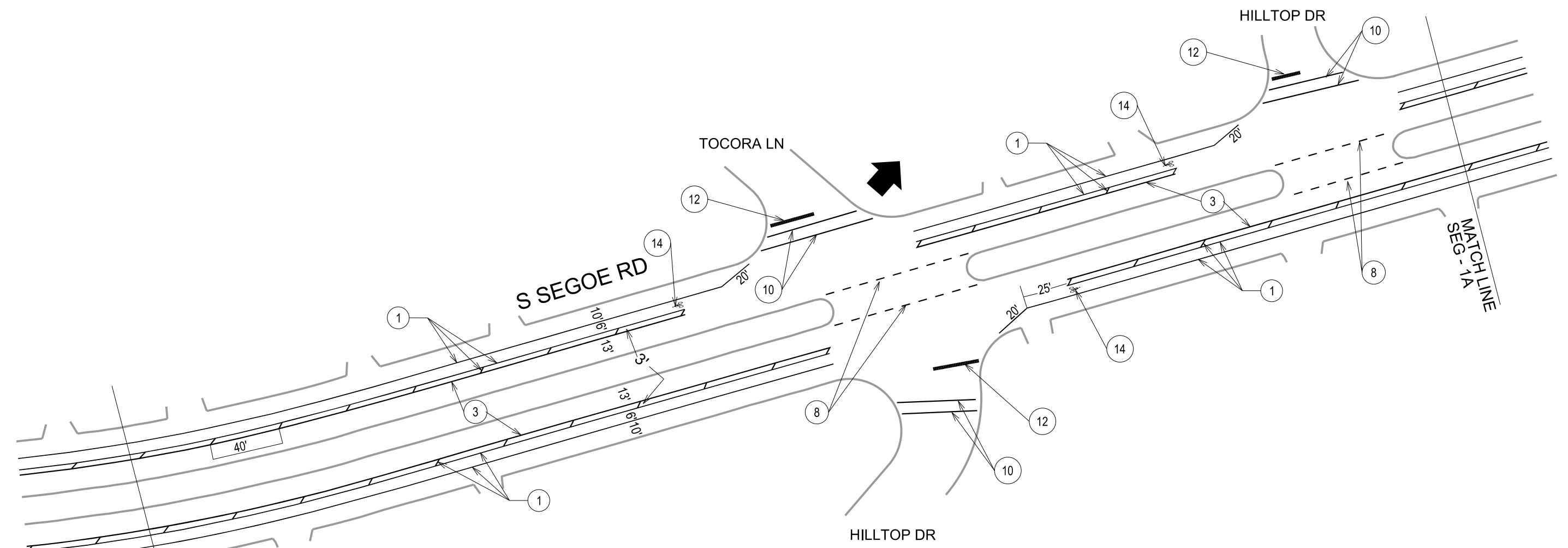

Callout	Bid Item	Description
1	60800	Pavement Marking Epoxy, 4-Inch, Solid White
2	60801	Pavement Marking Epoxy, 4-Inch Double Yellow
3	60802	Pavement Marking Epoxy, 6-Inch Solid White
4	60802	Pavement Marking Epoxy, 6-Inch White Skips, (10' Line, 30' Gap)
5	60802	Pavement Marking Epoxy, 6-Inch Yellow Skips (10' Line, 30' Gap)
6	60802	Pavement Marking Epoxy, 6-Inch White Skips, (2' Line, 6' Gap)
7	60803	Pavement Marking Epoxy, 8-Inch Solid White
8	60803	Pavement Marking Epoxy, 8-Inch White Skips, (5' Line, 5' Gap)
9	60803	Pavement Marking Epoxy, 8-Inch White Skips, (2' Line, 6' Gap)
10	60812	Pavement Marking Epoxy, 6-Inch White, Crosswalk
11	60815	Pavement Marking Epoxy, Continental Crosswalk, 18-Inch
12	60818	Pavement Marking Epoxy, 24-Inch White, Stop Line
13	60822	Pavement Marking Epoxy, Symbol, Bike Sharrow
14	60823	Pavement Marking Epoxy, Symbol, Bike Lane
15	60824	Pavement Marking Epoxy, Symbol, Bike Straight Arrow
16	60829	Pavement Marking Epoxy, Symbol, Left Arrow
17	60830	Pavement Marking Epoxy, Symbol, Right Arrow
18	60834	Pavement Marking Epoxy, Word, "ONLY"
19	60814	Pavement Marking Epoxy, 12-Inch White, Crosswalk

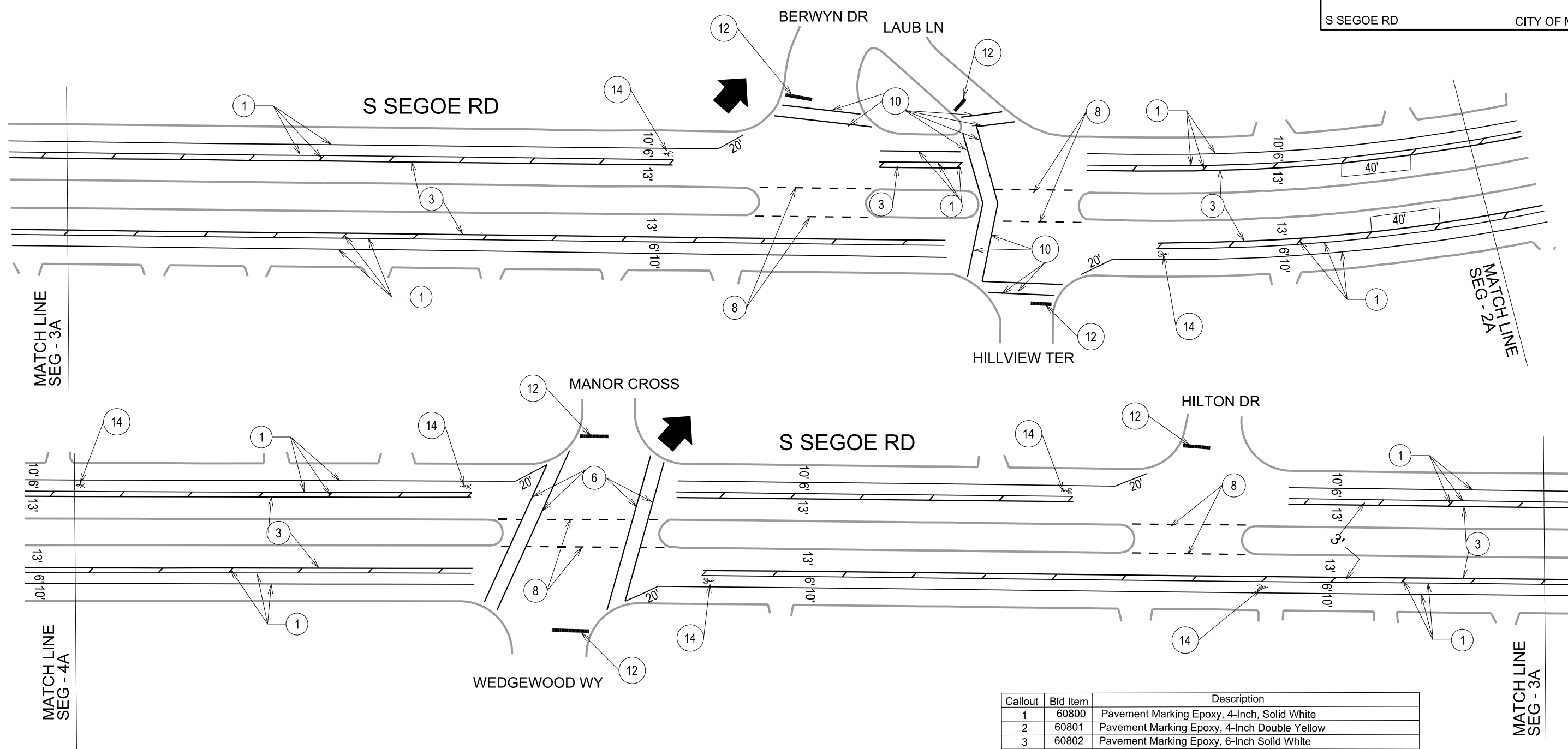

Callout	Bid Item	Description
1	60800	Pavement Marking Epoxy, 4-Inch, Solid White
2	60801	Pavement Marking Epoxy, 4-Inch Double Yellow
3	60802	Pavement Marking Epoxy, 6-Inch Solid White
4	60802	Pavement Marking Epoxy, 6-Inch White Skips, (10' Line, 30' Gap)
5	60802	Pavement Marking Epoxy, 6-Inch Yellow Skips (10' Line, 30' Gap)
6	60802	Pavement Marking Epoxy, 6-Inch White Skips, (2' Line, 6' Gap)
7	60803	Pavement Marking Epoxy, 8-Inch Solid White
8	60803	Pavement Marking Epoxy, 8-Inch White Skips, (5' Line, 5' Gap)
9	60803	Pavement Marking Epoxy, 8-Inch White Skips, (2' Line, 6' Gap)
10	60812	Pavement Marking Epoxy, 6-Inch White, Crosswalk
11	60815	Pavement Marking Epoxy, Continental Crosswalk, 18-Inch
12	60818	Pavement Marking Epoxy, 24-Inch White, Stop Line
13	60822	Pavement Marking Epoxy, Symbol, Bike Sharrow
14	60823	Pavement Marking Epoxy, Symbol, Bike Lane
15	60824	Pavement Marking Epoxy, Symbol, Bike Straight Arrow
16	60829	Pavement Marking Epoxy, Symbol, Left Arrow
17	60830	Pavement Marking Epoxy, Symbol, Right Arrow
18	60834	Pavement Marking Epoxy, Word, "ONLY"
19	60814	Pavement Marking Epoxy, 12-Inch White, Crosswalk

PLOT SCALE:
 PLOT NAME:
 REV. DATE:
 ORIGINATOR: CITY OF MADISON, TRAFFIC ENG. DIV.

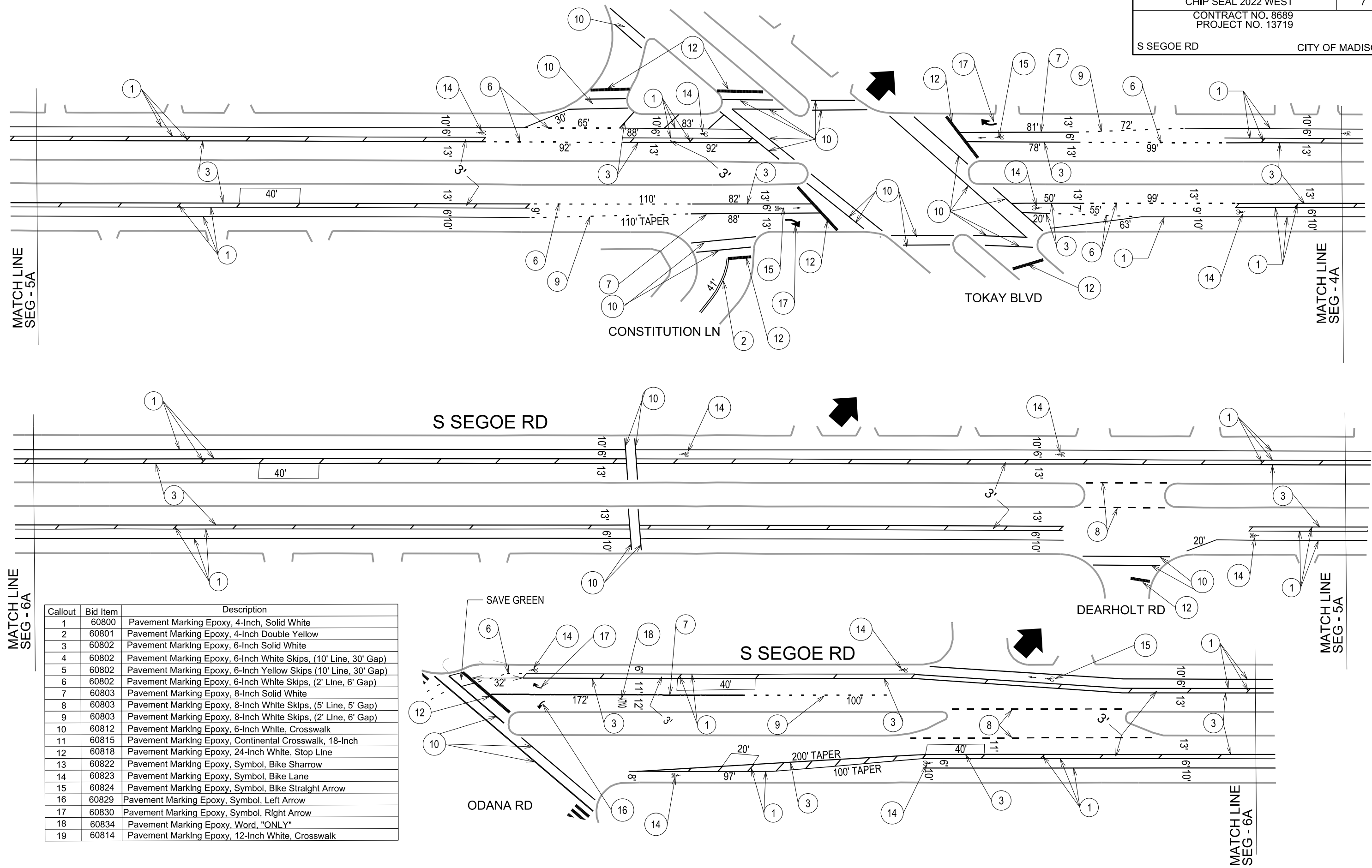

Callout	Bid Item	Description
1	60800	Pavement Marking Epoxy, 4-Inch, Solid White
2	60801	Pavement Marking Epoxy, 4-Inch Double Yellow
3	60802	Pavement Marking Epoxy, 6-Inch Solid White
4	60802	Pavement Marking Epoxy, 6-Inch White Skips, (10' Line, 30' Gap)
5	60802	Pavement Marking Epoxy, 6-Inch Yellow Skips (10' Line, 30' Gap)
6	60802	Pavement Marking Epoxy, 6-Inch White Skips, (2' Line, 6' Gap)
7	60803	Pavement Marking Epoxy, 8-Inch Solid White
8	60803	Pavement Marking Epoxy, 8-Inch White Skips, (5' Line, 5' Gap)
9	60803	Pavement Marking Epoxy, 8-Inch White Skips, (2' Line, 6' Gap)
10	60812	Pavement Marking Epoxy, 6-Inch White, Crosswalk
11	60815	Pavement Marking Epoxy, Continental Crosswalk, 18-Inch
12	60818	Pavement Marking Epoxy, 24-Inch White, Stop Line
13	60822	Pavement Marking Epoxy, Symbol, Bike Sharrow
14	60823	Pavement Marking Epoxy, Symbol, Bike Lane
15	60824	Pavement Marking Epoxy, Symbol, Bike Straight Arrow
16	60829	Pavement Marking Epoxy, Symbol, Left Arrow
17	60830	Pavement Marking Epoxy, Symbol, Right Arrow
18	60834	Pavement Marking Epoxy, Word, "ONLY"
19	60814	Pavement Marking Epoxy, 12-Inch White, Crosswalk

PLOT SCALE:
 PLOT NAME:
 REV. DATE:
 ORIGINATOR: CITY OF MADISON, TRAFFIC ENG. DIV.

MATCH LINE
SEG - 6A

MATCH LINE
SEG - 5A

MATCH LINE
SEG - 4A

MATCH LINE
SEG - 5A

MATCH LINE
SEG - 6A

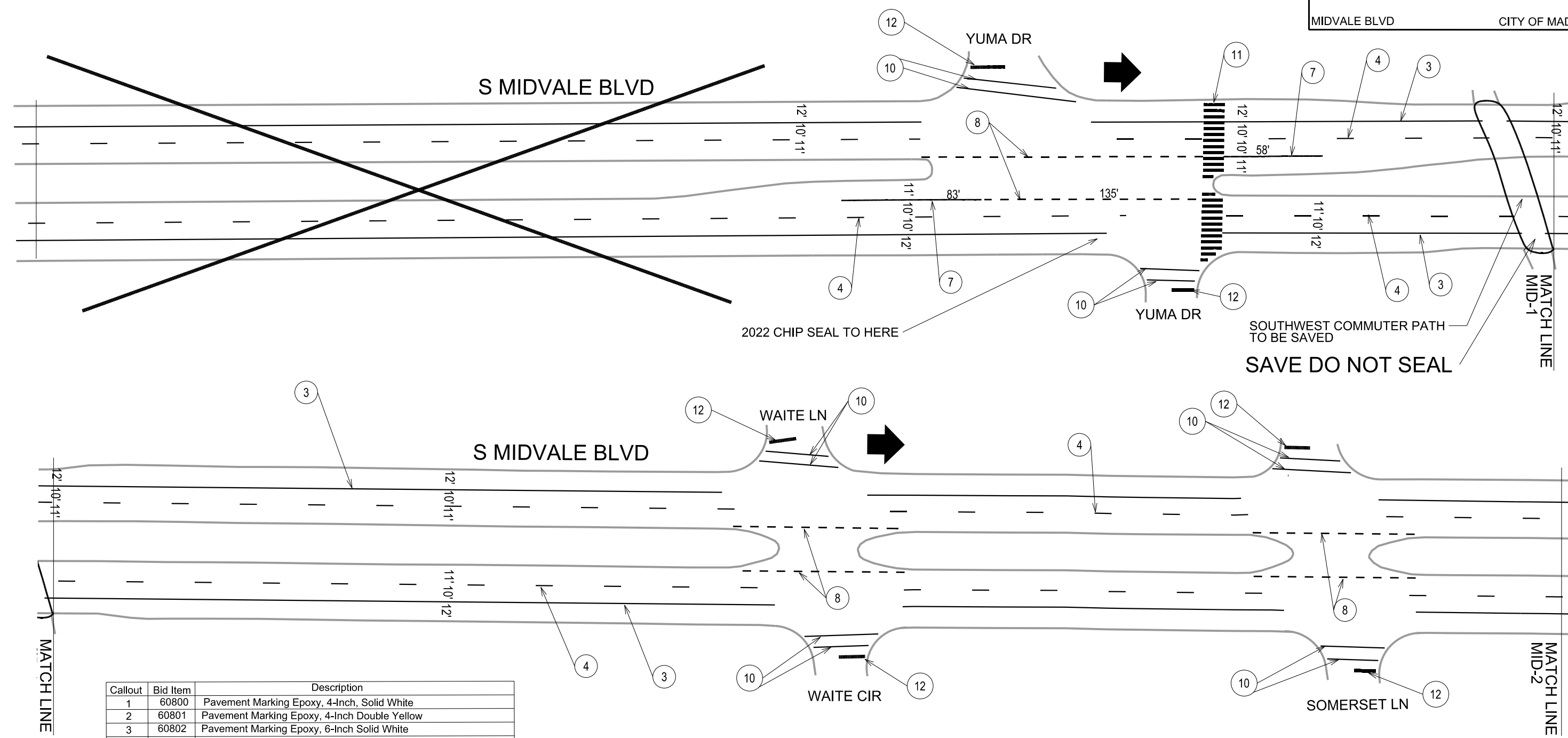

Callout	Bid Item	Description
1	60800	Pavement Marking Epoxy, 4-Inch, Solid White
2	60801	Pavement Marking Epoxy, 4-Inch Double Yellow
3	60802	Pavement Marking Epoxy, 6-Inch Solid White
4	60802	Pavement Marking Epoxy, 6-Inch White Skips, (10' Line, 30' Gap)
5	60802	Pavement Marking Epoxy, 6-Inch Yellow Skips (10' Line, 30' Gap)
6	60802	Pavement Marking Epoxy, 6-Inch White Skips, (2' Line, 6' Gap)
7	60803	Pavement Marking Epoxy, 8-Inch Solid White
8	60803	Pavement Marking Epoxy, 8-Inch White Skips, (5' Line, 5' Gap)
9	60803	Pavement Marking Epoxy, 8-Inch White Skips, (2' Line, 6' Gap)
10	60812	Pavement Marking Epoxy, 6-Inch White, Crosswalk
11	60815	Pavement Marking Epoxy, Continental Crosswalk, 18-Inch
12	60818	Pavement Marking Epoxy, 24-Inch White, Stop Line
13	60822	Pavement Marking Epoxy, Symbol, Bike Sharrow
14	60823	Pavement Marking Epoxy, Symbol, Bike Lane
15	60824	Pavement Marking Epoxy, Symbol, Bike Straight Arrow
16	60829	Pavement Marking Epoxy, Symbol, Left Arrow
17	60830	Pavement Marking Epoxy, Symbol, Right Arrow
18	60834	Pavement Marking Epoxy, Word, "ONLY"
19	60814	Pavement Marking Epoxy, 12-Inch White, Crosswalk

PLOT SCALE:
 PLOT NAME:
 REV. DATE:
 ORIGINATOR: CITY OF MADISON, TRAFFIC ENG. DIV.

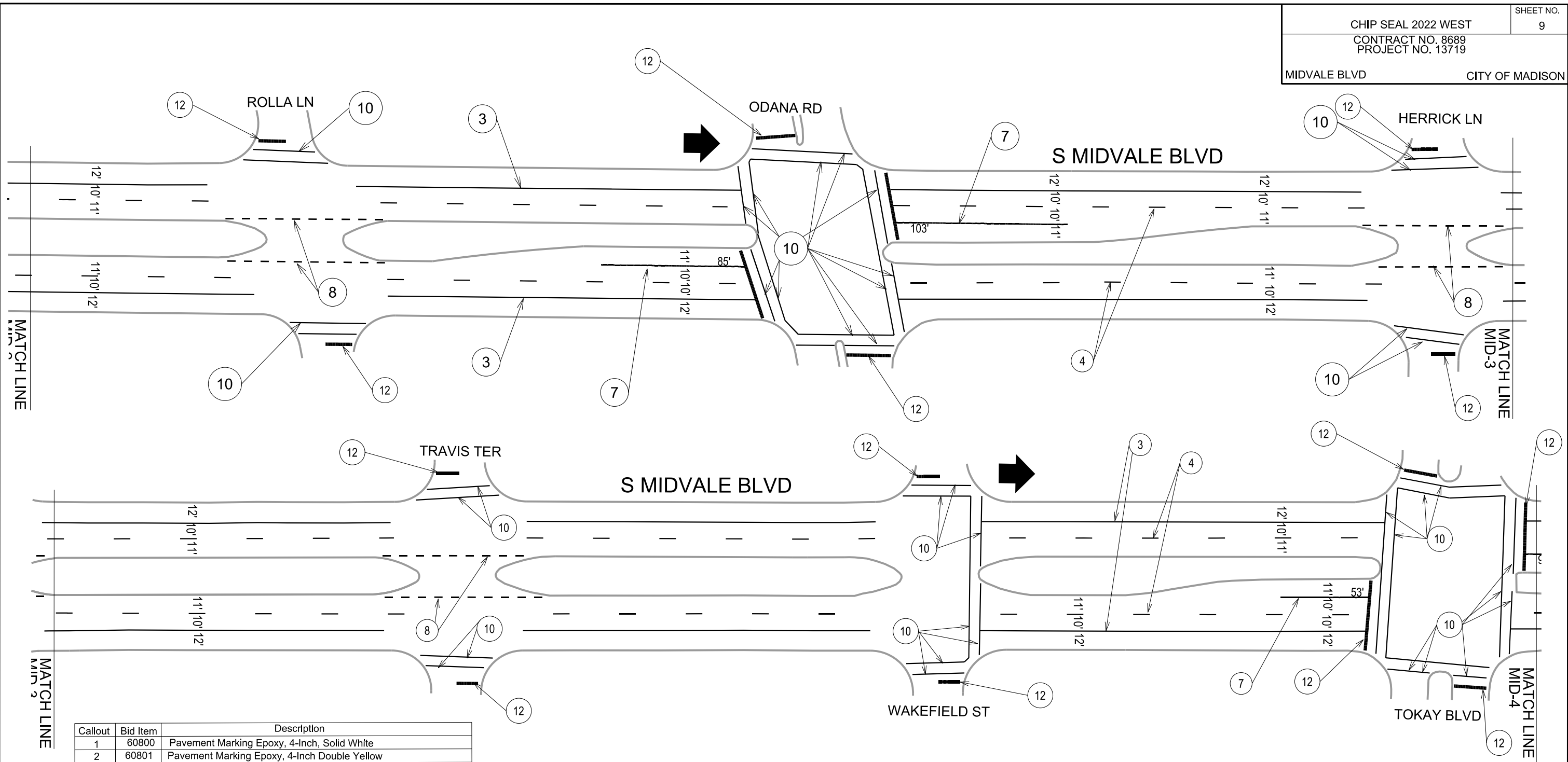

Callout	Bid Item	Description
1	60800	Pavement Marking Epoxy, 4-Inch, Solid White
2	60801	Pavement Marking Epoxy, 4-Inch Double Yellow
3	60802	Pavement Marking Epoxy, 6-Inch Solid White
4	60802	Pavement Marking Epoxy, 6-Inch White Skips, (10' Line, 30' Gap)
5	60802	Pavement Marking Epoxy, 6-Inch Yellow Skips (10' Line, 30' Gap)
6	60802	Pavement Marking Epoxy, 6-Inch White Skips, (2' Line, 6' Gap)
7	60803	Pavement Marking Epoxy, 8-Inch Solid White
8	60803	Pavement Marking Epoxy, 8-Inch White Skips, (5' Line, 5' Gap)
9	60803	Pavement Marking Epoxy, 8-Inch White Skips, (2' Line, 6' Gap)
10	60812	Pavement Marking Epoxy, 6-Inch White, Crosswalk
11	60815	Pavement Marking Epoxy, Continental Crosswalk, 18-Inch
12	60818	Pavement Marking Epoxy, 24-Inch White, Stop Line
13	60822	Pavement Marking Epoxy, Symbol, Bike Sharrow
14	60823	Pavement Marking Epoxy, Symbol, Bike Lane
15	60824	Pavement Marking Epoxy, Symbol, Bike Straight Arrow
16	60829	Pavement Marking Epoxy, Symbol, Left Arrow
17	60830	Pavement Marking Epoxy, Symbol, Right Arrow
18	60834	Pavement Marking Epoxy, Word, "ONLY"
19	60814	Pavement Marking Epoxy, 12-Inch White, Crosswalk

PLOT SCALE:

PLOT NAME:

REV. DATE:

ORIGINATOR: CITY OF MADISON, TRAFFIC ENG. DIV.

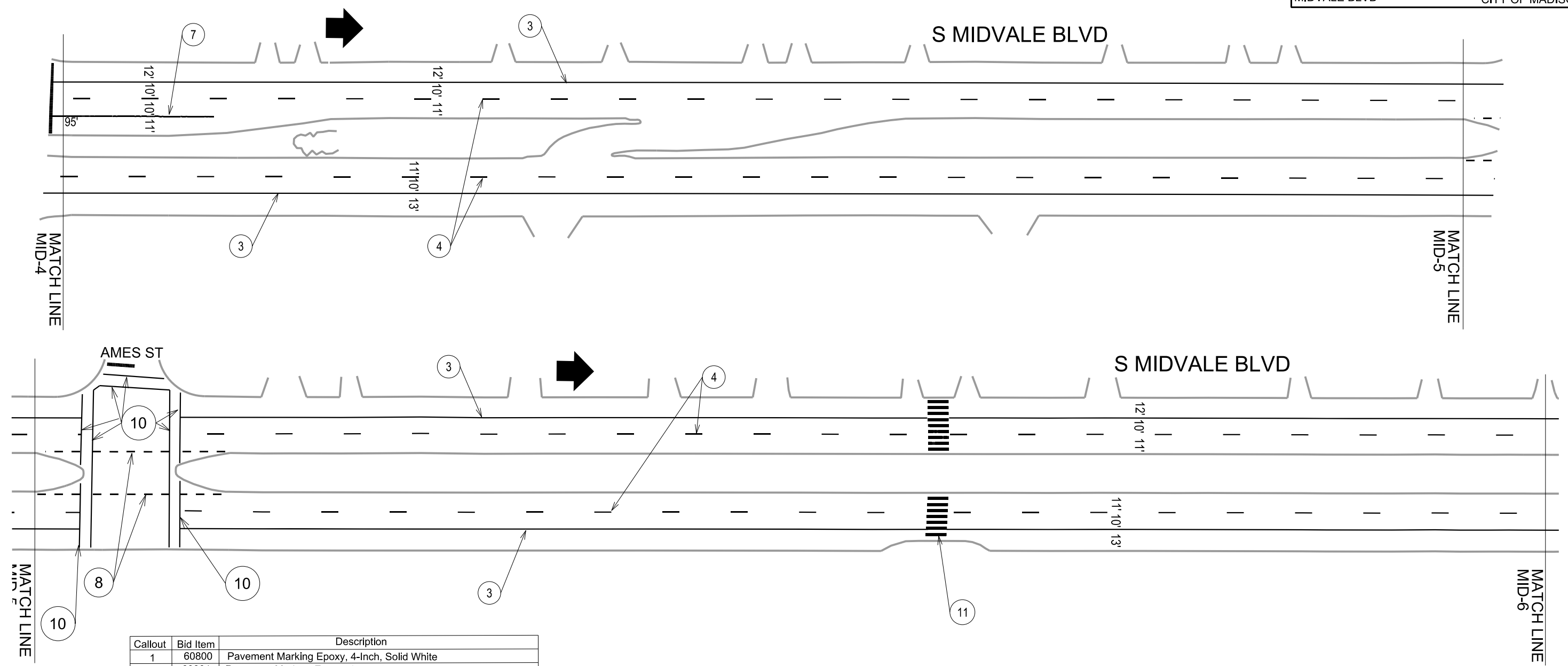

Callout	Bid Item	Description
1	60800	Pavement Marking Epoxy, 4-Inch, Solid White
2	60801	Pavement Marking Epoxy, 4-Inch Double Yellow
3	60802	Pavement Marking Epoxy, 6-Inch Solid White
4	60802	Pavement Marking Epoxy, 6-Inch White Skips, (10' Line, 30' Gap)
5	60802	Pavement Marking Epoxy, 6-Inch Yellow Skips (10' Line, 30' Gap)
6	60802	Pavement Marking Epoxy, 6-Inch White Skips, (2' Line, 6' Gap)
7	60803	Pavement Marking Epoxy, 8-Inch Solid White
8	60803	Pavement Marking Epoxy, 8-Inch White Skips, (5' Line, 5' Gap)
9	60803	Pavement Marking Epoxy, 8-Inch White Skips, (2' Line, 6' Gap)
10	60812	Pavement Marking Epoxy, 6-Inch White, Crosswalk
11	60815	Pavement Marking Epoxy, Continental Crosswalk, 18-Inch
12	60818	Pavement Marking Epoxy, 24-Inch White, Stop Line
13	60822	Pavement Marking Epoxy, Symbol, Bike Sharrow
14	60823	Pavement Marking Epoxy, Symbol, Bike Lane
15	60824	Pavement Marking Epoxy, Symbol, Bike Straight Arrow
16	60829	Pavement Marking Epoxy, Symbol, Left Arrow
17	60830	Pavement Marking Epoxy, Symbol, Right Arrow
18	60834	Pavement Marking Epoxy, Word, "ONLY"
19	60814	Pavement Marking Epoxy, 12-Inch White, Crosswalk

PLOT SCALE:
 PLOT NAME:
 REV. DATE:
 ORIGINATOR: CITY OF MADISON, TRAFFIC ENG. DIV.

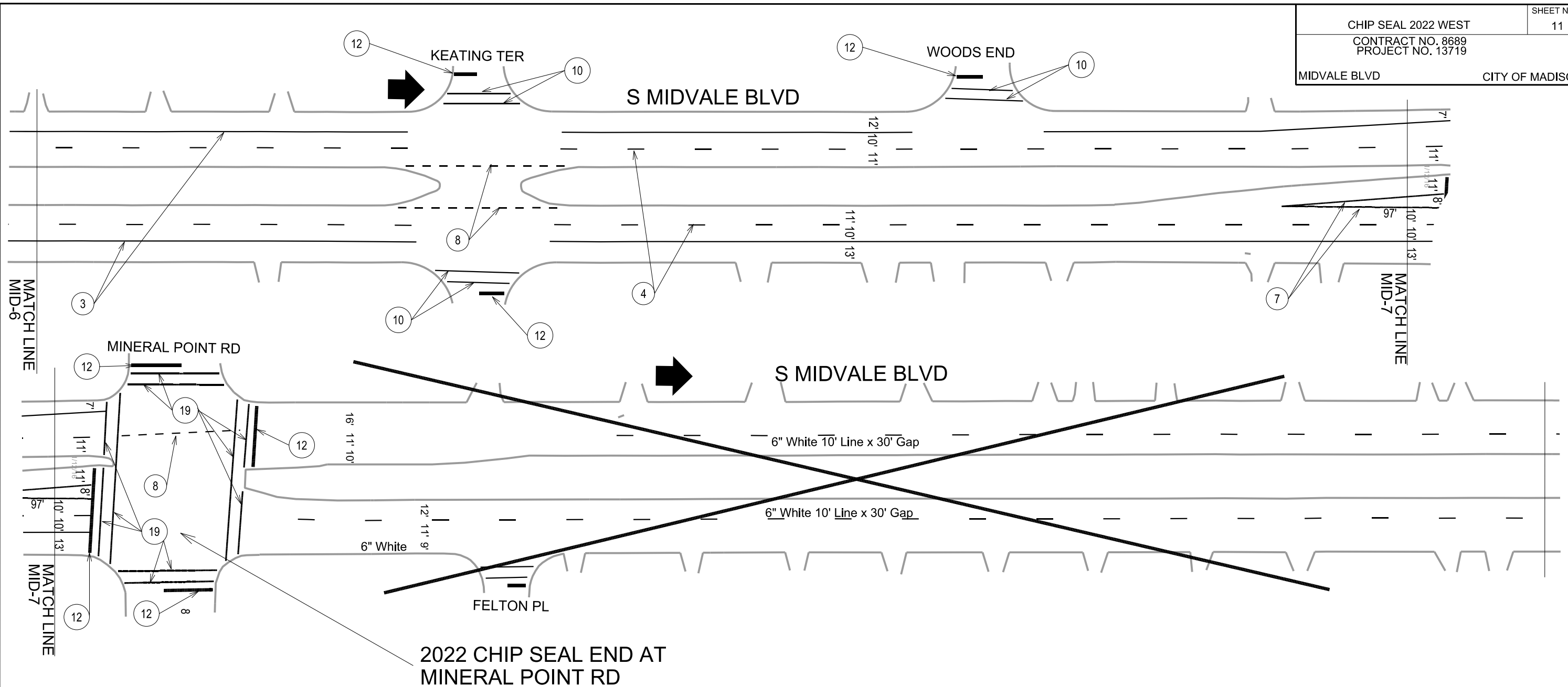

2022 CHIP SEAL END AT
MINERAL POINT RD

Callout	Bid Item	Description
1	60800	Pavement Marking Epoxy, 4-Inch, Solid White
2	60801	Pavement Marking Epoxy, 4-Inch Double Yellow
3	60802	Pavement Marking Epoxy, 6-Inch Solid White
4	60802	Pavement Marking Epoxy, 6-Inch White Skips, (10' Line, 30' Gap)
5	60802	Pavement Marking Epoxy, 6-Inch Yellow Skips (10' Line, 30' Gap)
6	60802	Pavement Marking Epoxy, 6-Inch White Skips, (2' Line, 6' Gap)
7	60803	Pavement Marking Epoxy, 8-Inch Solid White
8	60803	Pavement Marking Epoxy, 8-Inch White Skips, (5' Line, 5' Gap)
9	60803	Pavement Marking Epoxy, 8-Inch White Skips, (2' Line, 6' Gap)
10	60812	Pavement Marking Epoxy, 6-Inch White, Crosswalk
11	60815	Pavement Marking Epoxy, Continental Crosswalk, 18-Inch
12	60818	Pavement Marking Epoxy, 24-Inch White, Stop Line
13	60822	Pavement Marking Epoxy, Symbol, Bike Sharrow
14	60823	Pavement Marking Epoxy, Symbol, Bike Lane
15	60824	Pavement Marking Epoxy, Symbol, Bike Straight Arrow
16	60829	Pavement Marking Epoxy, Symbol, Left Arrow
17	60830	Pavement Marking Epoxy, Symbol, Right Arrow
18	60834	Pavement Marking Epoxy, Word, "ONLY"
19	60814	Pavement Marking Epoxy, 12-Inch White, Crosswalk

PLOT SCALE:

PLOT NAME:

REV. DATE:

ORIGINATOR: CITY OF MADISON, TRAFFIC ENG. DIV.

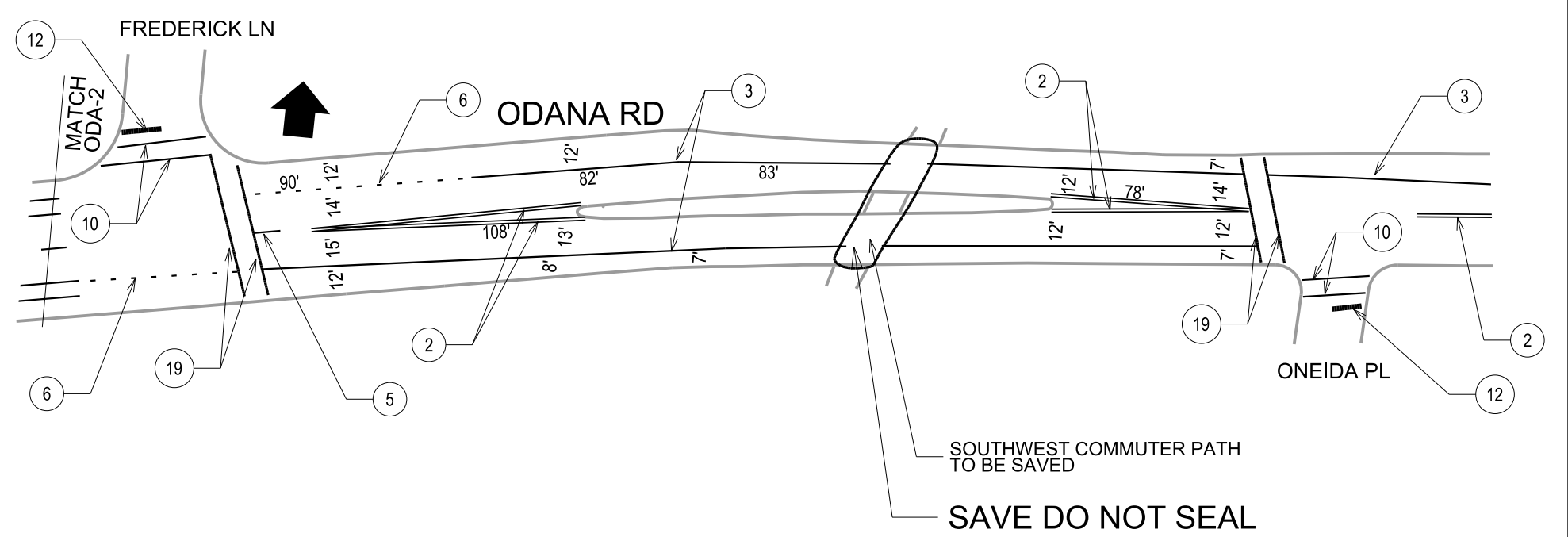
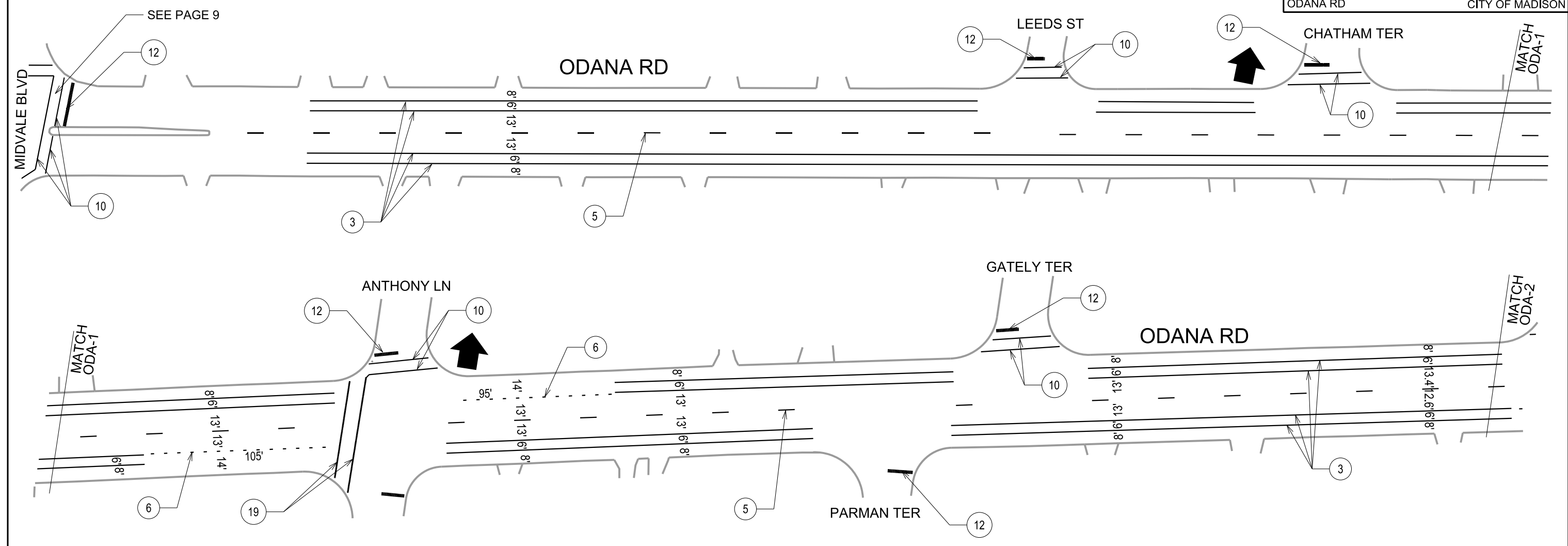

Callout	Bid Item	Description
1	60800	Pavement Marking Epoxy, 4-Inch, Solid White
2	60801	Pavement Marking Epoxy, 4-Inch Double Yellow
3	60802	Pavement Marking Epoxy, 6-Inch Solid White
4	60802	Pavement Marking Epoxy, 6-Inch White Skips, (10' Line, 30' Gap)
5	60802	Pavement Marking Epoxy, 6-Inch Yellow Skips (10' Line, 30' Gap)
6	60802	Pavement Marking Epoxy, 6-Inch White Skips, (2' Line, 6' Gap)
7	60803	Pavement Marking Epoxy, 8-Inch Solid White
8	60803	Pavement Marking Epoxy, 8-Inch White Skips, (5' Line, 5' Gap)
9	60803	Pavement Marking Epoxy, 8-Inch White Skips, (2' Line, 6' Gap)
10	60812	Pavement Marking Epoxy, 6-Inch White, Crosswalk
11	60815	Pavement Marking Epoxy, Continental Crosswalk, 18-Inch
12	60818	Pavement Marking Epoxy, 24-Inch White, Stop Line
13	60822	Pavement Marking Epoxy, Symbol, Bike Sharrow
14	60823	Pavement Marking Epoxy, Symbol, Bike Lane
15	60824	Pavement Marking Epoxy, Symbol, Bike Straight Arrow
16	60829	Pavement Marking Epoxy, Symbol, Left Arrow
17	60830	Pavement Marking Epoxy, Symbol, Right Arrow
18	60834	Pavement Marking Epoxy, Word, "ONLY"
19	60814	Pavement Marking Epoxy, 12-Inch White, Crosswalk

PLOT SCALE:

PLOT NAME:

REV. DATE:

ORIGINATOR: CITY OF MADISON, TRAFFIC ENG. DIV.

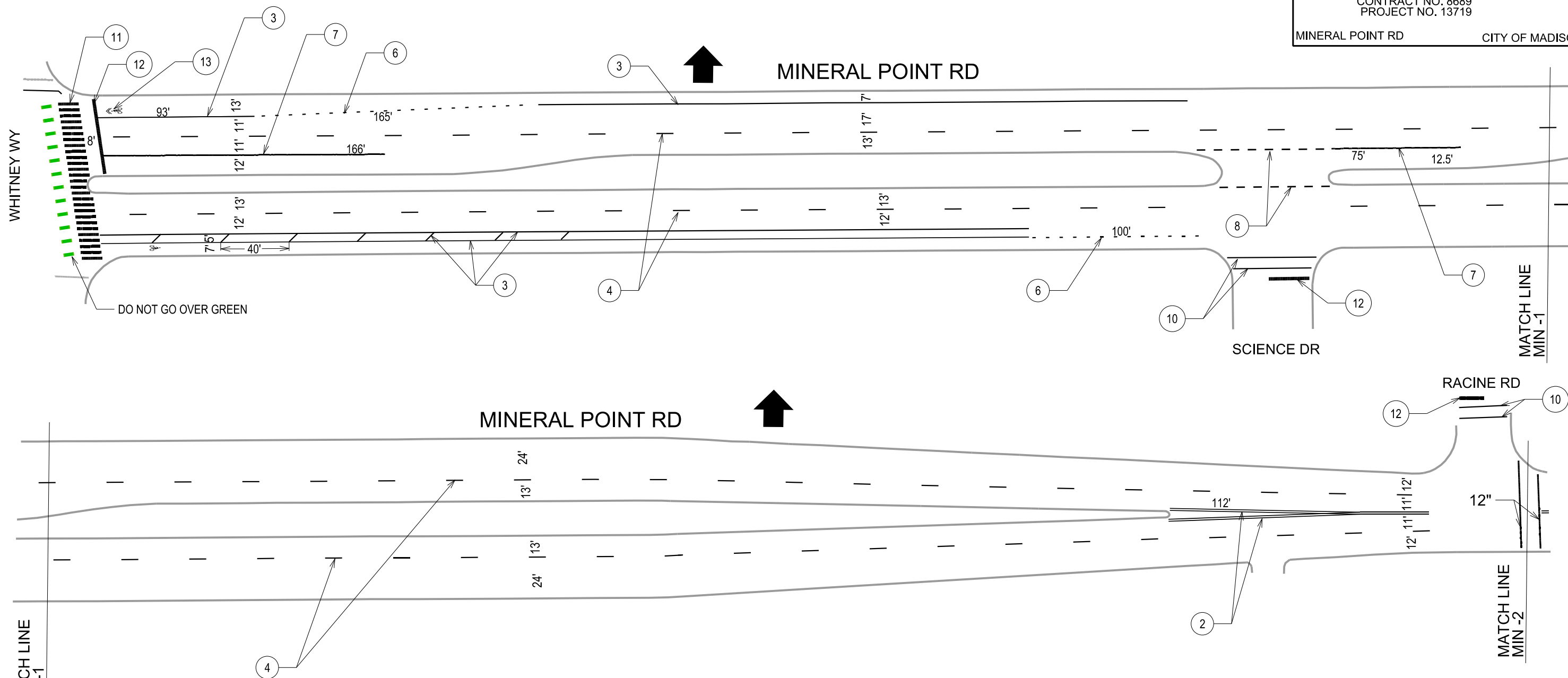

Callout	Bid Item	Description
1	60800	Pavement Marking Epoxy, 4-Inch, Solid White
2	60801	Pavement Marking Epoxy, 4-Inch Double Yellow
3	60802	Pavement Marking Epoxy, 6-Inch Solid White
4	60802	Pavement Marking Epoxy, 6-Inch White Skips, (10' Line, 30' Gap)
5	60802	Pavement Marking Epoxy, 6-Inch Yellow Skips (10' Line, 30' Gap)
6	60802	Pavement Marking Epoxy, 6-Inch White Skips, (2' Line, 6' Gap)
7	60803	Pavement Marking Epoxy, 8-Inch Solid White
8	60803	Pavement Marking Epoxy, 8-Inch White Skips, (5' Line, 5' Gap)
9	60803	Pavement Marking Epoxy, 8-Inch White Skips, (2' Line, 6' Gap)
10	60812	Pavement Marking Epoxy, 6-Inch White, Crosswalk
11	60815	Pavement Marking Epoxy, Continental Crosswalk, 18-Inch
12	60818	Pavement Marking Epoxy, 24-Inch White, Stop Line
13	60822	Pavement Marking Epoxy, Symbol, Bike Sharrow
14	60823	Pavement Marking Epoxy, Symbol, Bike Lane
15	60824	Pavement Marking Epoxy, Symbol, Bike Straight Arrow
16	60829	Pavement Marking Epoxy, Symbol, Left Arrow
17	60830	Pavement Marking Epoxy, Symbol, Right Arrow
18	60834	Pavement Marking Epoxy, Word, "ONLY"
19	60814	Pavement Marking Epoxy, 12-Inch White, Crosswalk

PLOT SCALE:

PLOT NAME:

REV. DATE:

ORIGINATOR: CITY OF MADISON, TRAFFIC ENG. DIV.

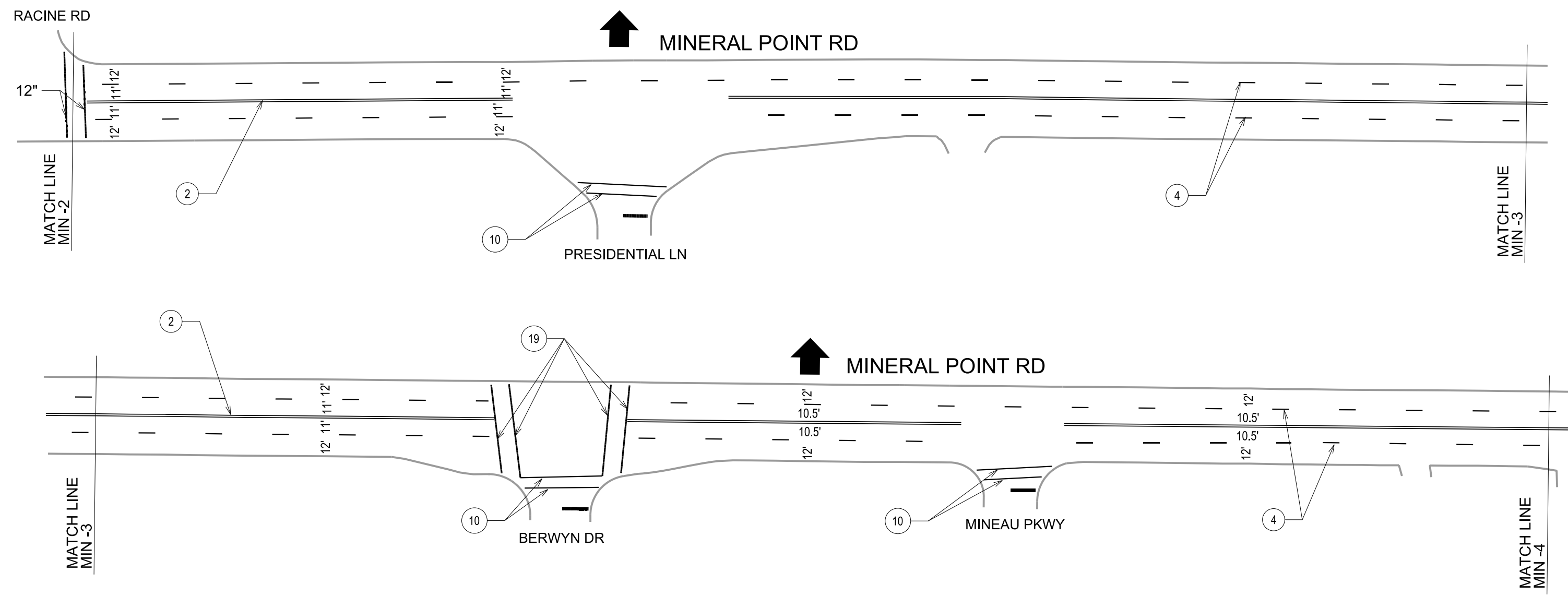

Callout	Bid Item	Description
1	60800	Pavement Marking Epoxy, 4-Inch, Solid White
2	60801	Pavement Marking Epoxy, 4-Inch Double Yellow
3	60802	Pavement Marking Epoxy, 6-Inch Solid White
4	60802	Pavement Marking Epoxy, 6-Inch White Skips, (10' Line, 30' Gap)
5	60802	Pavement Marking Epoxy, 6-Inch Yellow Skips (10' Line, 30' Gap)
6	60802	Pavement Marking Epoxy, 6-Inch White Skips, (2' Line, 6' Gap)
7	60803	Pavement Marking Epoxy, 8-Inch Solid White
8	60803	Pavement Marking Epoxy, 8-Inch White Skips, (5' Line, 5' Gap)
9	60803	Pavement Marking Epoxy, 8-Inch White Skips, (2' Line, 6' Gap)
10	60812	Pavement Marking Epoxy, 6-Inch White, Crosswalk
11	60815	Pavement Marking Epoxy, Continental Crosswalk, 18-Inch
12	60818	Pavement Marking Epoxy, 24-Inch White, Stop Line
13	60822	Pavement Marking Epoxy, Symbol, Bike Sharrow
14	60823	Pavement Marking Epoxy, Symbol, Bike Lane
15	60824	Pavement Marking Epoxy, Symbol, Bike Straight Arrow
16	60829	Pavement Marking Epoxy, Symbol, Left Arrow
17	60830	Pavement Marking Epoxy, Symbol, Right Arrow
18	60834	Pavement Marking Epoxy, Word, "ONLY"
19	60814	Pavement Marking Epoxy, 12-Inch White, Crosswalk

PLOT SCALE:
 PLOT NAME:
 REV. DATE:
 ORIGINATOR: CITY OF MADISON, TRAFFIC ENG. DIV.

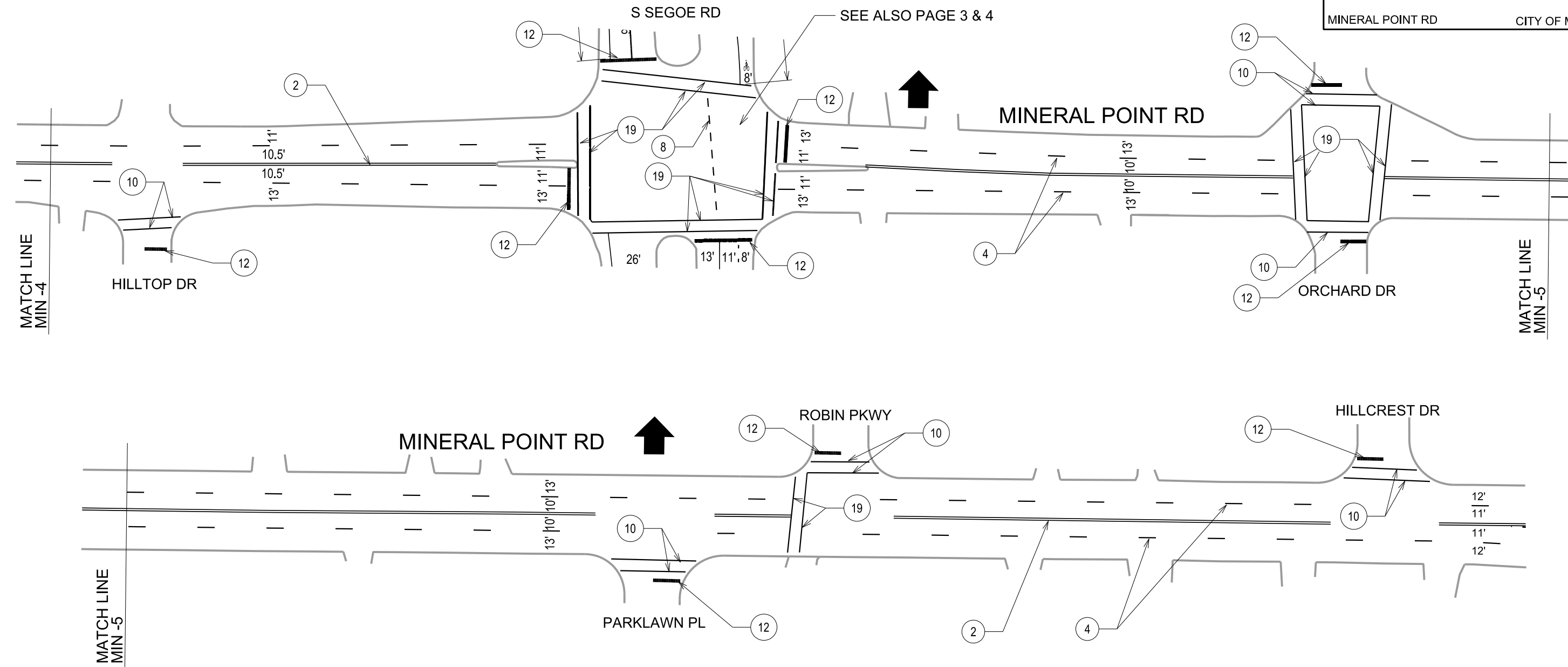

Callout	Bid Item	Description
1	60800	Pavement Marking Epoxy, 4-Inch, Solid White
2	60801	Pavement Marking Epoxy, 4-Inch Double Yellow
3	60802	Pavement Marking Epoxy, 6-Inch Solid White
4	60802	Pavement Marking Epoxy, 6-Inch White Skips, (10' Line, 30' Gap)
5	60802	Pavement Marking Epoxy, 6-Inch Yellow Skips (10' Line, 30' Gap)
6	60802	Pavement Marking Epoxy, 6-Inch White Skips, (2' Line, 6' Gap)
7	60803	Pavement Marking Epoxy, 8-Inch Solid White
8	60803	Pavement Marking Epoxy, 8-Inch White Skips, (5' Line, 5' Gap)
9	60803	Pavement Marking Epoxy, 8-Inch White Skips, (2' Line, 6' Gap)
10	60812	Pavement Marking Epoxy, 6-Inch White, Crosswalk
11	60815	Pavement Marking Epoxy, Continental Crosswalk, 18-Inch
12	60818	Pavement Marking Epoxy, 24-Inch White, Stop Line
13	60822	Pavement Marking Epoxy, Symbol, Bike Sharrow
14	60823	Pavement Marking Epoxy, Symbol, Bike Lane
15	60824	Pavement Marking Epoxy, Symbol, Bike Straight Arrow
16	60829	Pavement Marking Epoxy, Symbol, Left Arrow
17	60830	Pavement Marking Epoxy, Symbol, Right Arrow
18	60834	Pavement Marking Epoxy, Word, "ONLY"
19	60814	Pavement Marking Epoxy, 12-Inch White, Crosswalk

PLOT SCALE:

PLOT NAME:

REV. DATE:

ORIGINATOR: CITY OF MADISON, TRAFFIC ENG. DIV.

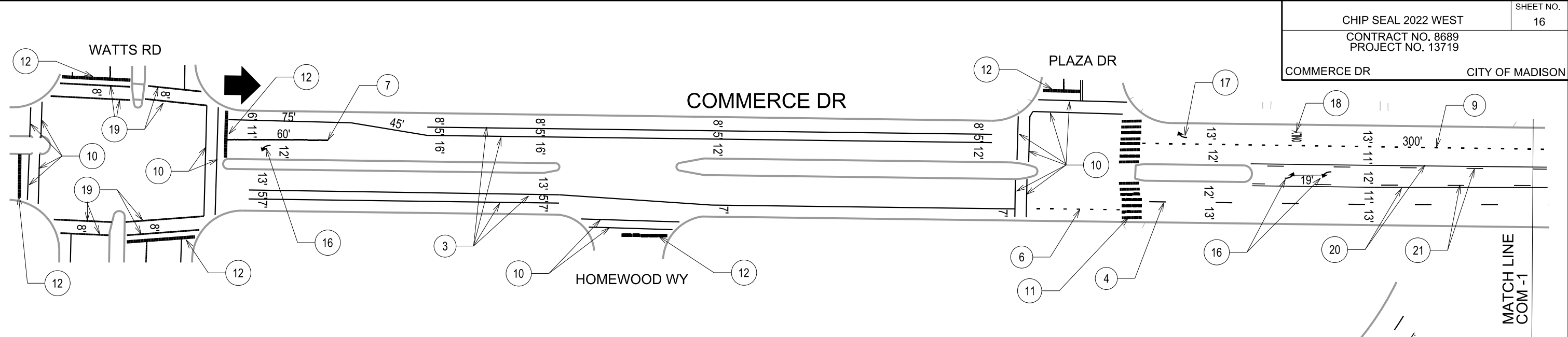

Callout	Bid Item	Description
1	60800	Pavement Marking Epoxy, 4-Inch, Solid White
2	60801	Pavement Marking Epoxy, 4-Inch Double Yellow
3	60802	Pavement Marking Epoxy, 6-Inch Solid White
4	60802	Pavement Marking Epoxy, 6-Inch White Skips, (10' Line, 30' Gap)
5	60802	Pavement Marking Epoxy, 6-Inch Yellow Skips (10' Line, 30' Gap)
6	60802	Pavement Marking Epoxy, 6-Inch White Skips, (2' Line, 6' Gap)
7	60803	Pavement Marking Epoxy, 8-Inch Solid White
8	60803	Pavement Marking Epoxy, 8-Inch White Skips, (5' Line, 5' Gap)
9	60803	Pavement Marking Epoxy, 8-Inch White Skips, (2' Line, 6' Gap)
10	60812	Pavement Marking Epoxy, 6-Inch White, Crosswalk
11	60815	Pavement Marking Epoxy, Continental Crosswalk, 18-Inch
12	60818	Pavement Marking Epoxy, 24-Inch White, Stop Line
13	60822	Pavement Marking Epoxy, Symbol, Bike Sharrow
14	60823	Pavement Marking Epoxy, Symbol, Bike Lane
15	60824	Pavement Marking Epoxy, Symbol, Bike Straight Arrow
16	60829	Pavement Marking Epoxy, Symbol, Left Arrow
17	60830	Pavement Marking Epoxy, Symbol, Right Arrow
18	60834	Pavement Marking Epoxy, Word, "ONLY"
19	60814	Pavement Marking Epoxy, 12-Inch White, Crosswalk
20	60800	Pavement Marking Epoxy, 4-Inch, Solid Yellow
21	60800	Pavement Marking Epoxy, 4-Inch, Yellow Skips (10' Line, 30' Gap)

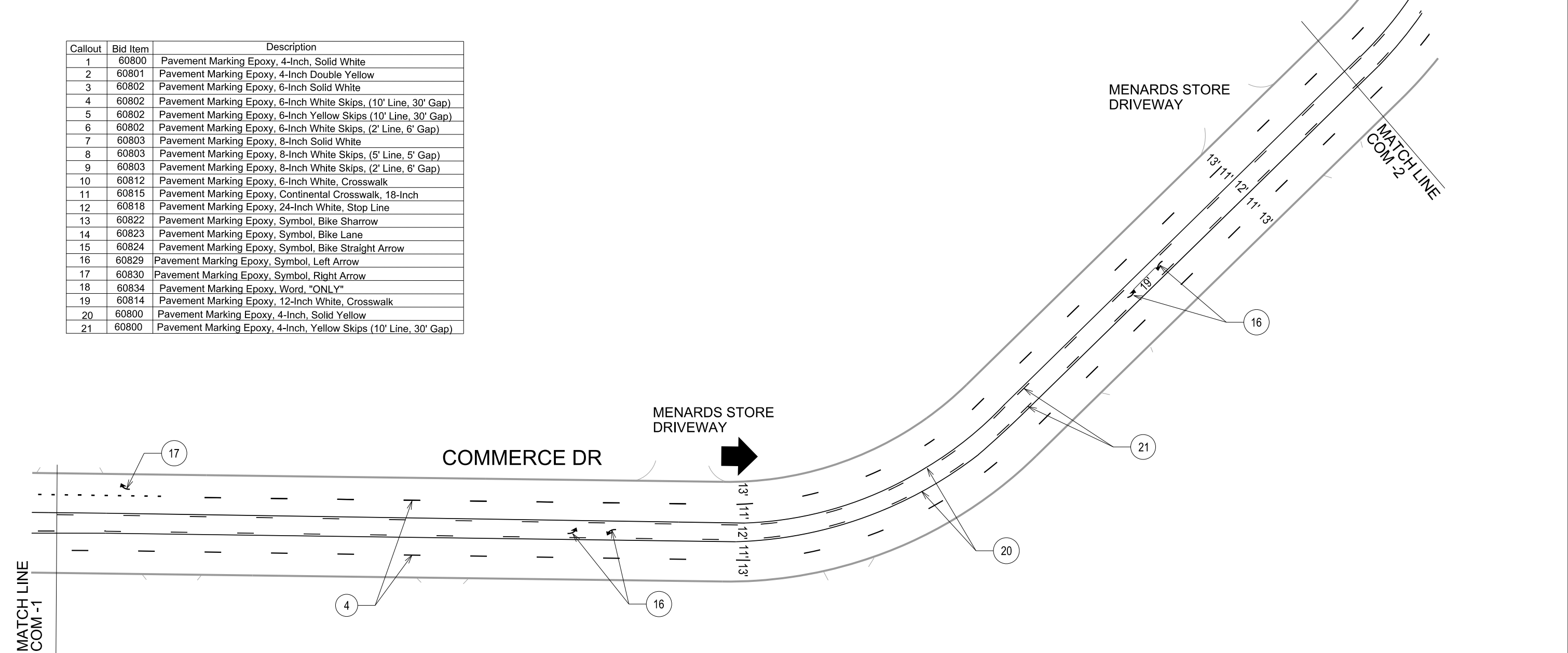

PLOT SCALE:
 PLOT NAME:
 REV. DATE:
 ORIGINATOR: CITY OF MADISON, TRAFFIC ENG. DIV.

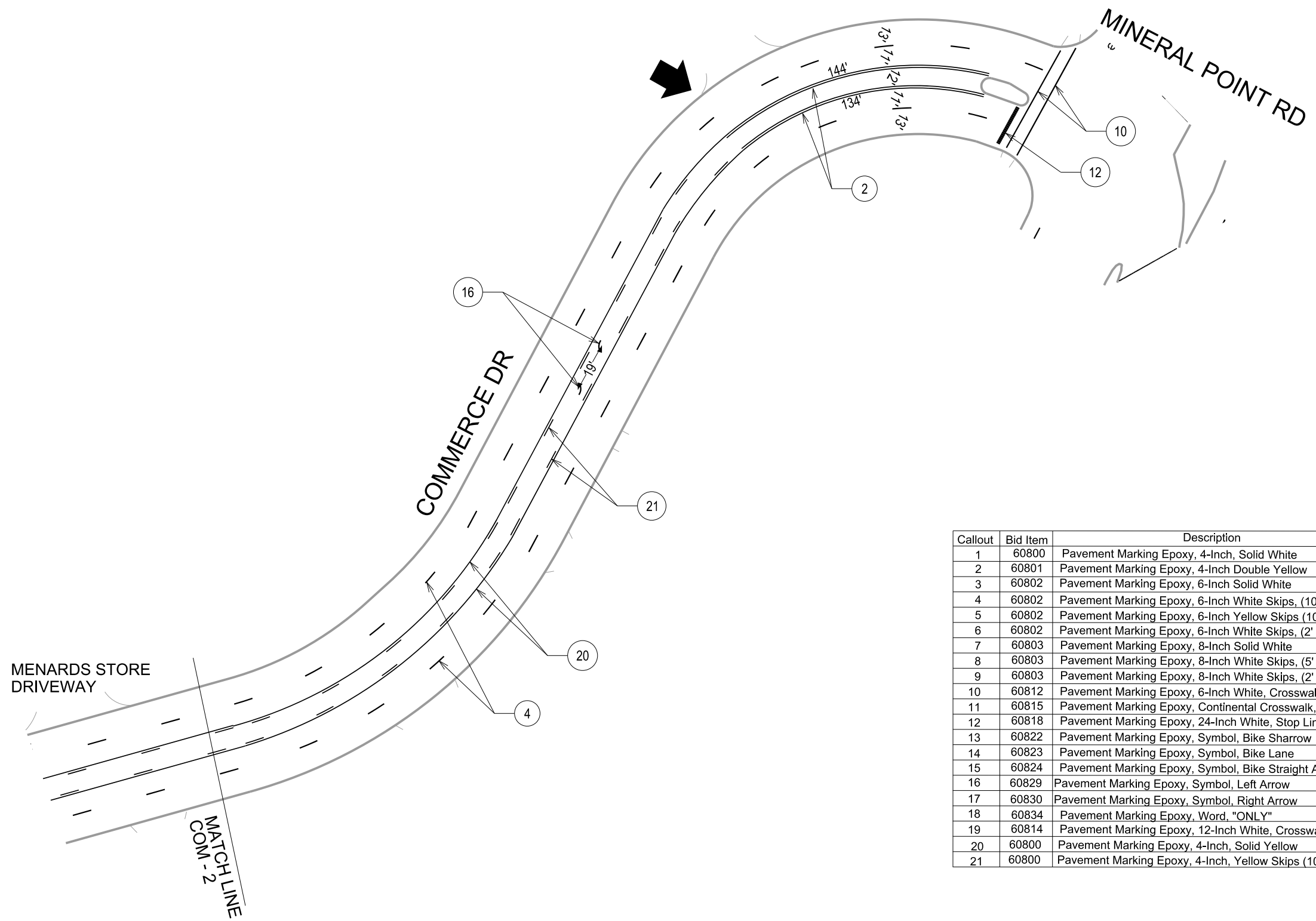

Callout	Bid Item	Description
1	60800	Pavement Marking Epoxy, 4-Inch, Solid White
2	60801	Pavement Marking Epoxy, 4-Inch Double Yellow
3	60802	Pavement Marking Epoxy, 6-Inch Solid White
4	60802	Pavement Marking Epoxy, 6-Inch White Skips, (10' Line, 30' Gap)
5	60802	Pavement Marking Epoxy, 6-Inch Yellow Skips (10' Line, 30' Gap)
6	60802	Pavement Marking Epoxy, 6-Inch White Skips, (2' Line, 6' Gap)
7	60803	Pavement Marking Epoxy, 8-Inch Solid White
8	60803	Pavement Marking Epoxy, 8-Inch White Skips, (5' Line, 5' Gap)
9	60803	Pavement Marking Epoxy, 8-Inch White Skips, (2' Line, 6' Gap)
10	60812	Pavement Marking Epoxy, 6-Inch White, Crosswalk
11	60815	Pavement Marking Epoxy, Continental Crosswalk, 18-Inch
12	60818	Pavement Marking Epoxy, 24-Inch White, Stop Line
13	60822	Pavement Marking Epoxy, Symbol, Bike Sharrow
14	60823	Pavement Marking Epoxy, Symbol, Bike Lane
15	60824	Pavement Marking Epoxy, Symbol, Bike Straight Arrow
16	60829	Pavement Marking Epoxy, Symbol, Left Arrow
17	60830	Pavement Marking Epoxy, Symbol, Right Arrow
18	60834	Pavement Marking Epoxy, Word, "ONLY"
19	60814	Pavement Marking Epoxy, 12-Inch White, Crosswalk
20	60800	Pavement Marking Epoxy, 4-Inch, Solid Yellow
21	60800	Pavement Marking Epoxy, 4-Inch, Yellow Skips (10' Line, 30' Gap)

PLOT SCALE:
 PLOT NAME:
 REV. DATE:
 ORIGINATOR: CITY OF MADISON, TRAFFIC ENG. DIV.

PERMANENT PAVEMENT MARKINGS

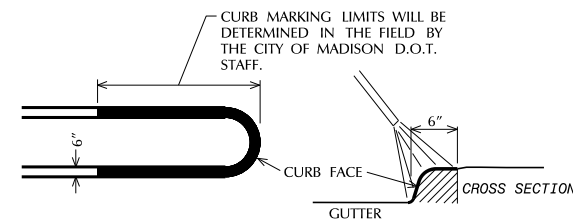
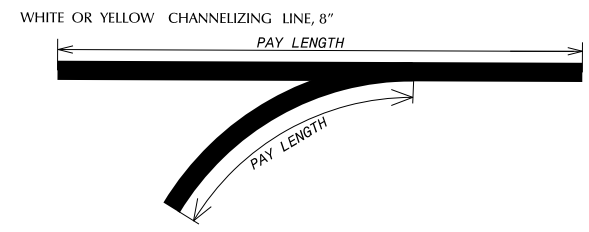
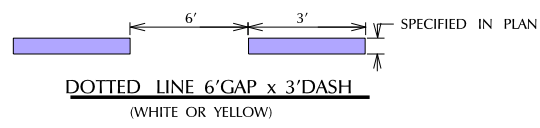
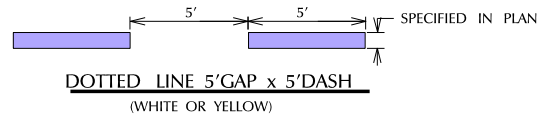
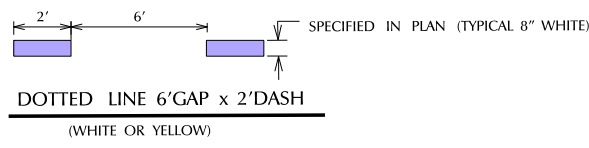
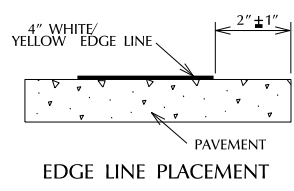
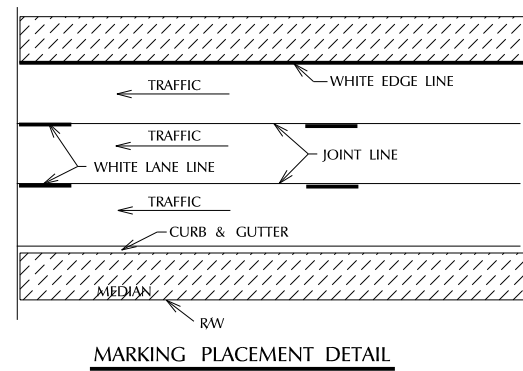
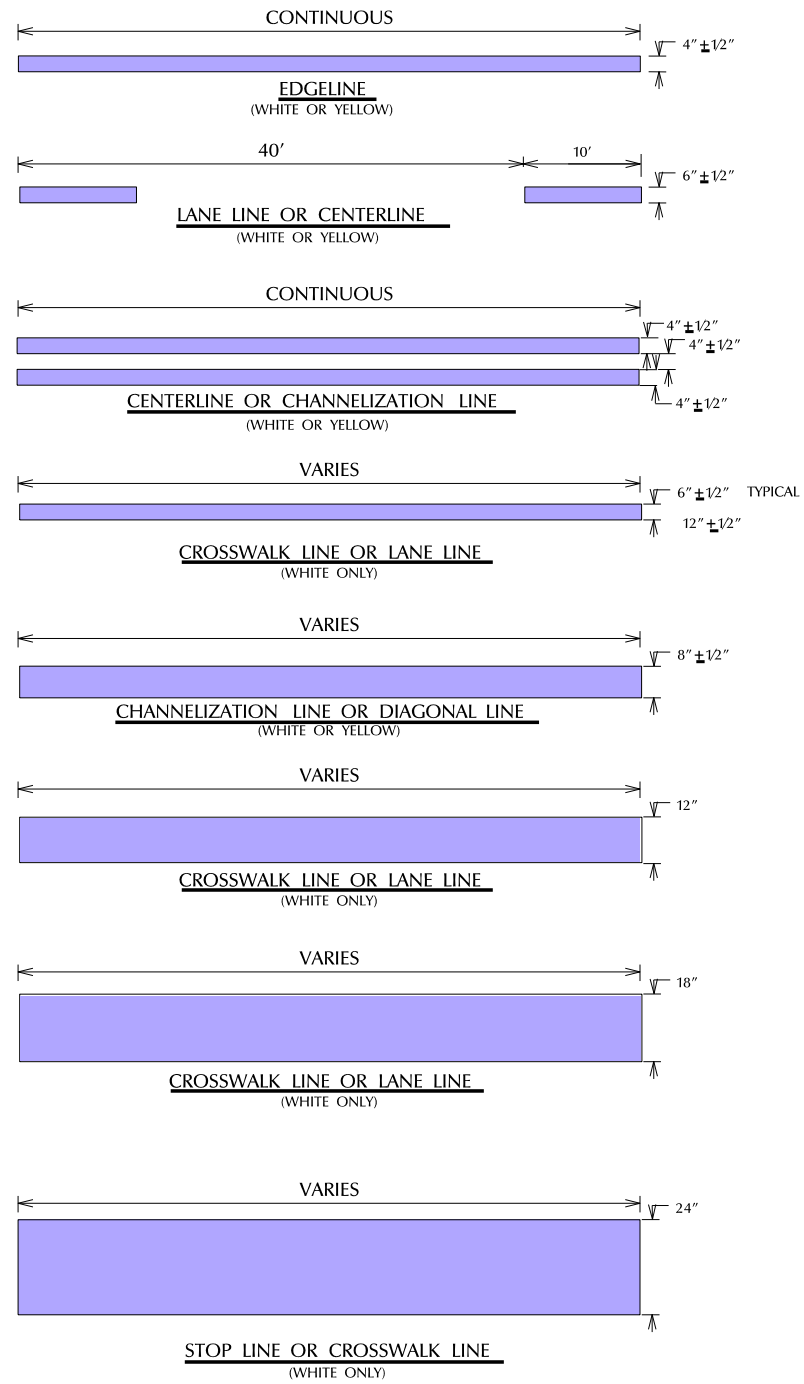

GENERAL NOTES FOR EPOXY PAVEMENT MARKINGS

THE CONTRACTOR SHALL APPLY ALL MARKINGS IN ACCORDANCE WITH THE STATE OF WISCONSIN MANUAL ON TRAFFIC CONTROL DEVICES.

AT STREET INTERSECTIONS, MARKINGS START OR END AT THE MARKED CROSSWALK. THE PROPERTY LINE EXTENDED, IF THERE IS NO MARKED CROSSWALK.

CROSSWALKS AND STOP BARS WILL BE PLACED NO CLOSER THAN 2' TO THE FACE OF CURB.

THE CONTRACTOR SHALL ADHERE TO THE TRAFFIC SPECIFICATION IN THE SPECIAL PROVISIONS AT ALL TIMES.

FOR MORE INFORMATION AND FULL SIZE PATTERNS FOR ARROWS & WORD LEGENDS ARE AVAILABLE AT THE CITY OF MADISON TRAFFIC ENGINEERING FIELD OPERATIONS FACILITY 1120 SAYLE ST. (608) 266-4767

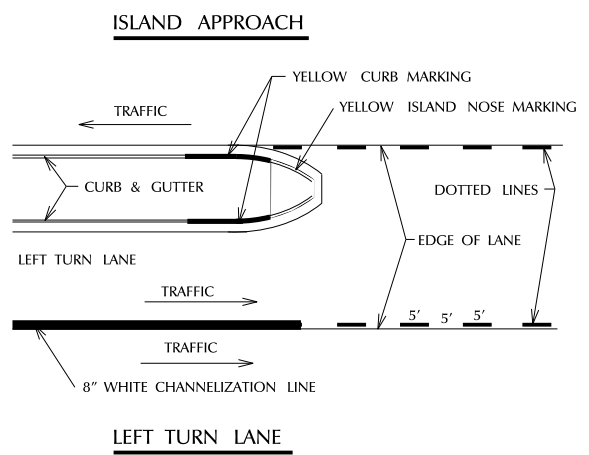
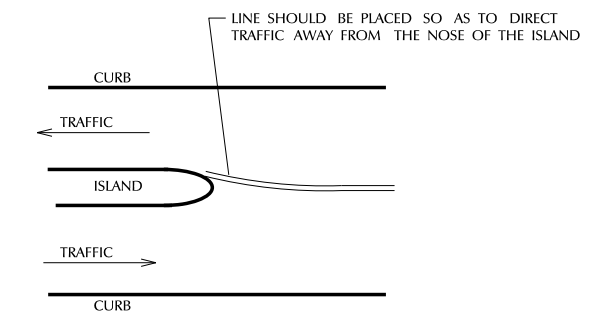

2009

CITY OF MADISON
ENGINEERING DIVISION

**PAVEMENT MARKING
DETAILS
PAGE 1**

STANDARD DETAIL DRAWING # 6.37

D-4

D-5

SPECIAL CROSSWALKS

SPECIAL CROSSWALKS HAVE TWO(2) 12-INCH WIDE LINES PLACED ACROSS THE TRAFFIC FLOW AND 24-INCH WIDE CROSSBARS IN LINE WITH THE TRAFFIC FLOW.

THE SPACING OR GAP BETWEEN THE CROSSBARS IS DETERMINED IN THE FIELD AND VARIES BETWEEN 24 TO 48 INCHES SO THAT NO CROSSBAR IS PLACED IN THE MAIN WHEEL TRACK AREA.

TYPICALLY, A CROSSBAR IS CENTERED ON THE CENTERLINE. ANOTHER CROSSBAR IS CENTERED BETWEEN THE WHEEL TRACKS AND ANOTHER CROSSBAR PLACED BETWEEN THE OUTSIDE WHEEL TRACK AND THE EDGE OF GUTTER OR PAVEMENT. IN NO CASE SHALL THE CROSSBAR BE PLACED IN OR NEXT TO THE GUTTER SECTION.

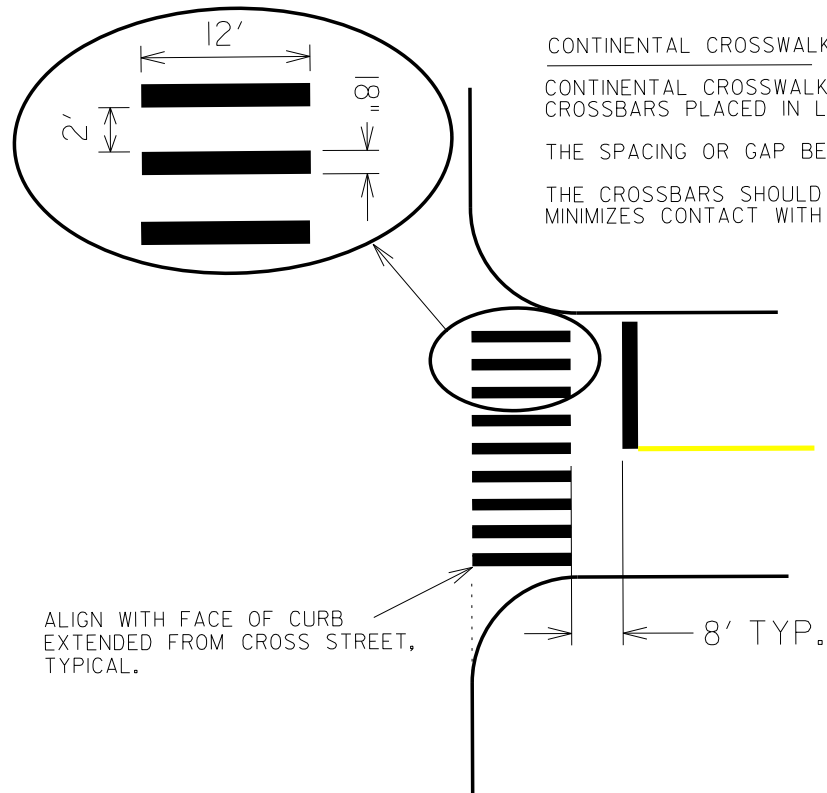
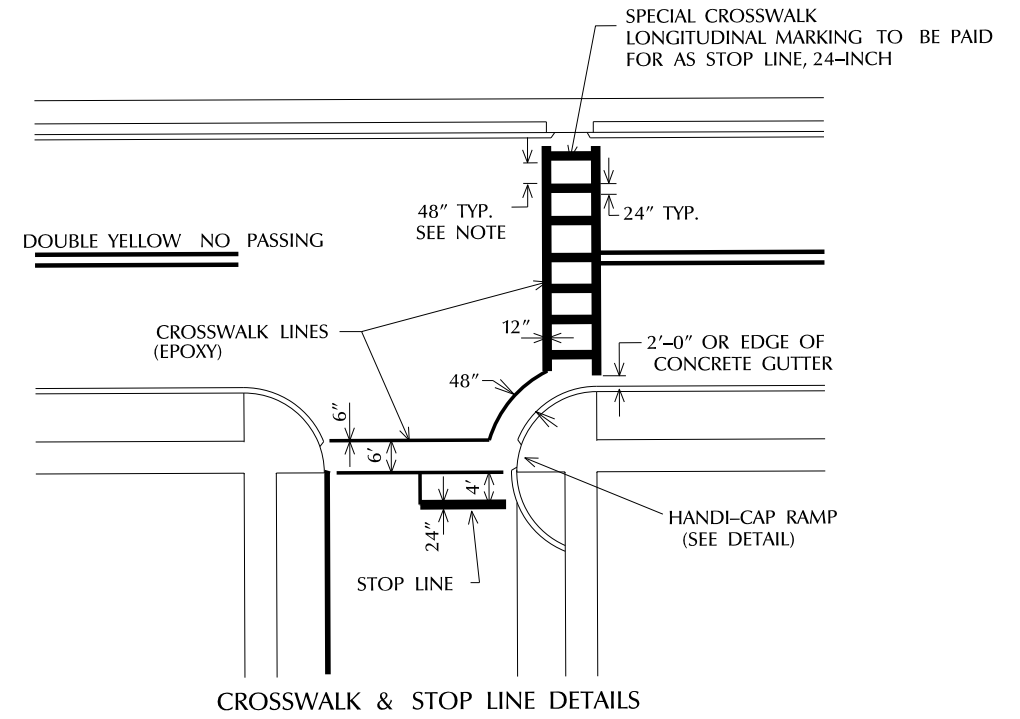

CONTINENTAL CROSSWALKS

CONTINENTAL CROSSWALKS HAVE 18 INCH WIDE 12 FOOT LONG CROSSBARS PLACED IN LINE WITH THE TRAFFIC FLOW.

THE SPACING OR GAP BETWEEN THE CROSSBARS IS 24 INCHES

THE CROSSBARS SHOULD BE PLACED IN A MANNER THAT MINIMIZES CONTACT WITH VEHICLES TIRES.

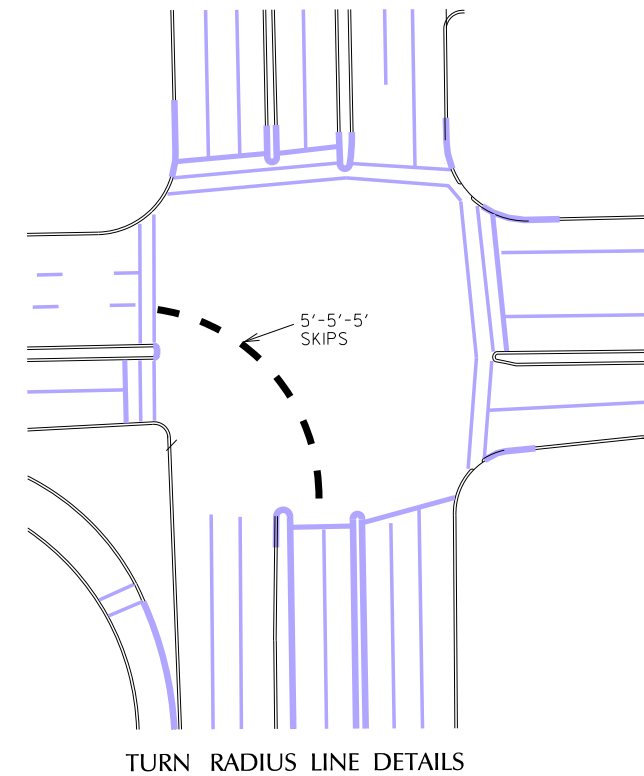

2009

CITY OF MADISON ENGINEERING DIVISION
PAVEMENT MARKING DETAILS PAGE 2
STANDARD DETAIL DRAWING # 6.38

RESTRICTED TRAFFIC LANE MARKING DETAILS

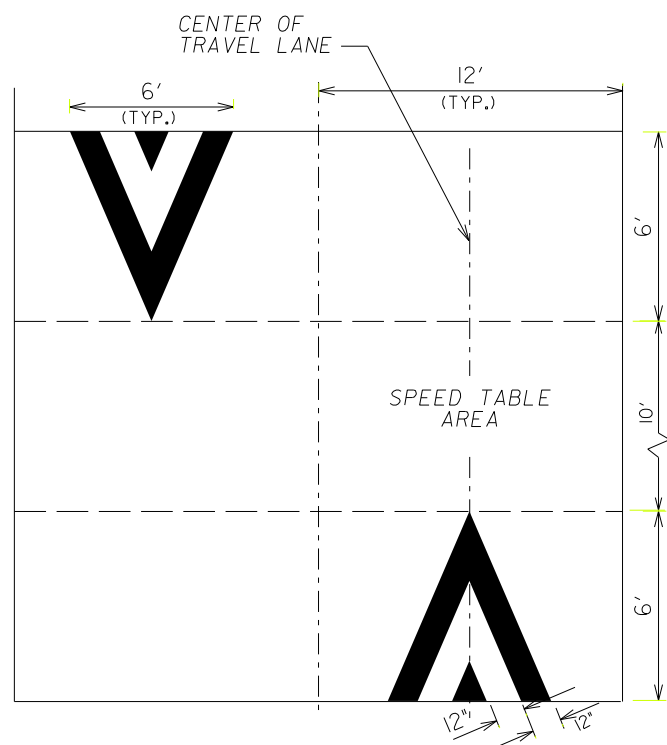

MARKINGS FOR SPEED HUMPS

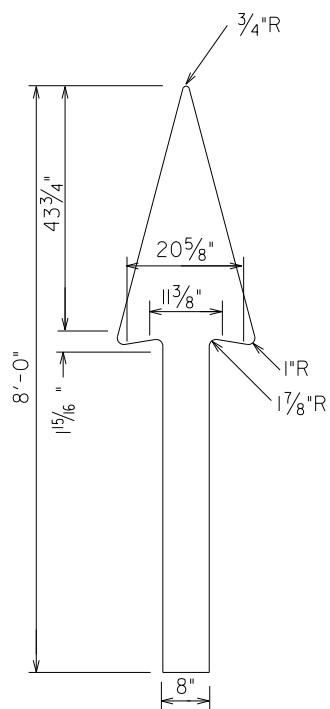

STRAIGHT ARROW

LEFT ARROW'S DIMENSIONS SAME AS SHOWN ON RIGHT ARROW

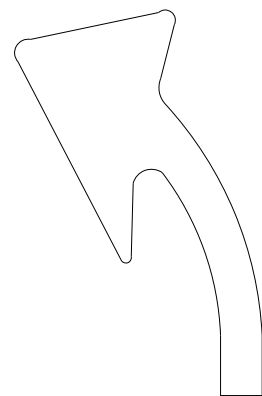

LEFT ARROW

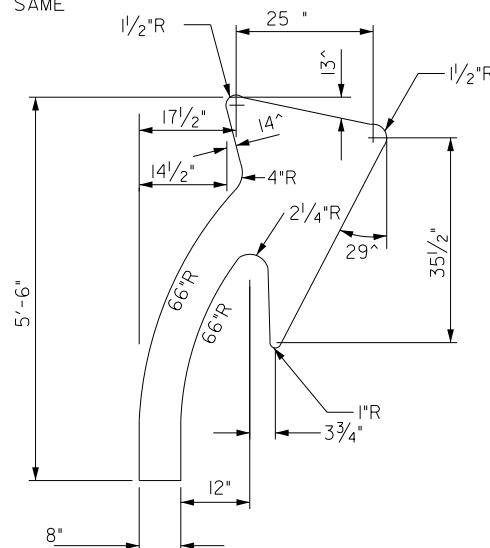

RIGHT ARROW

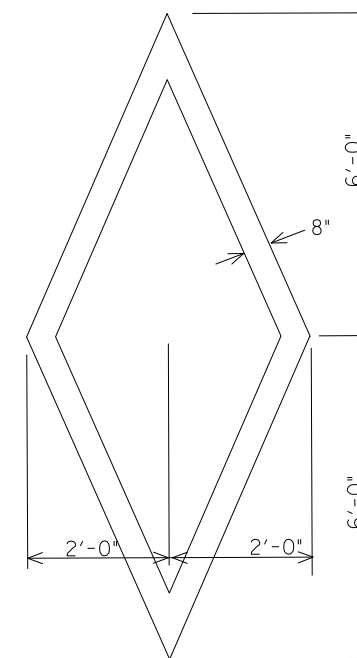

RESTRICTED LANE SYMBOL

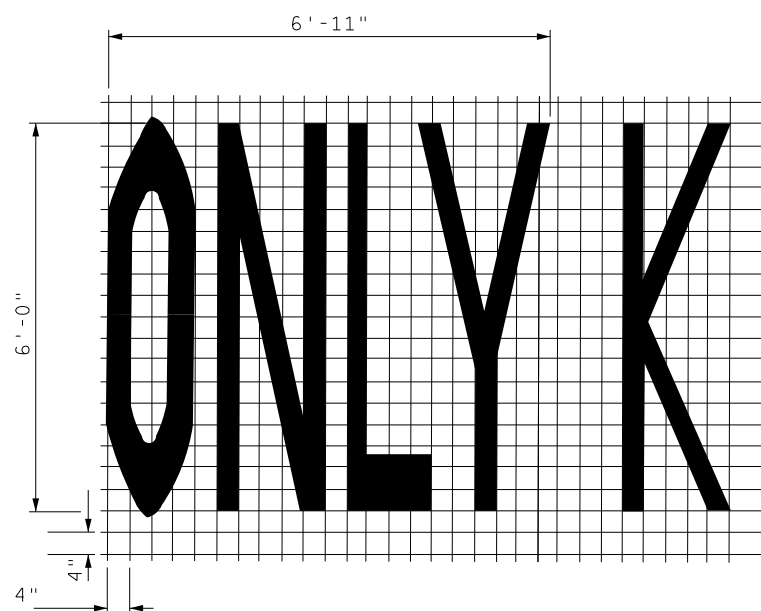

WORD LEGEND

FULL SIZE PATTERNS FOR ARROWS & WORD LEGENDS ARE AVAILABLE AT:
CITY OF MADISON TRAFFIC ENGINEERING
FIELD OPERATIONS FACILITY
1120 SAYLE ST. (608)266-4767

FEB 2005

CITY OF MADISON
ENGINEERING DIVISION

PAVEMENT MARKING
DETAILS
PAGE 3

STANDARD DETAIL DRAWING # 6.39

D-6

TE STANDARD SHARROW CENTERLINE DETAIL

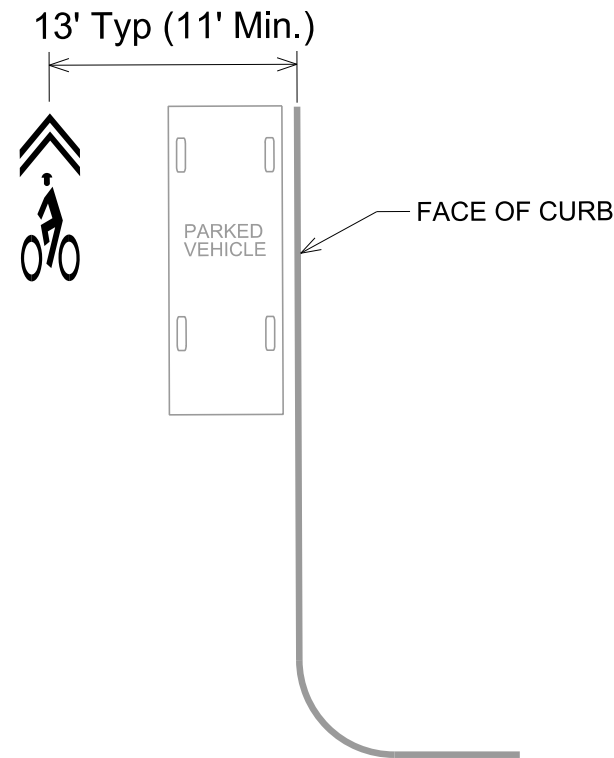

Sharrow Centerline
WITH On Street Parking

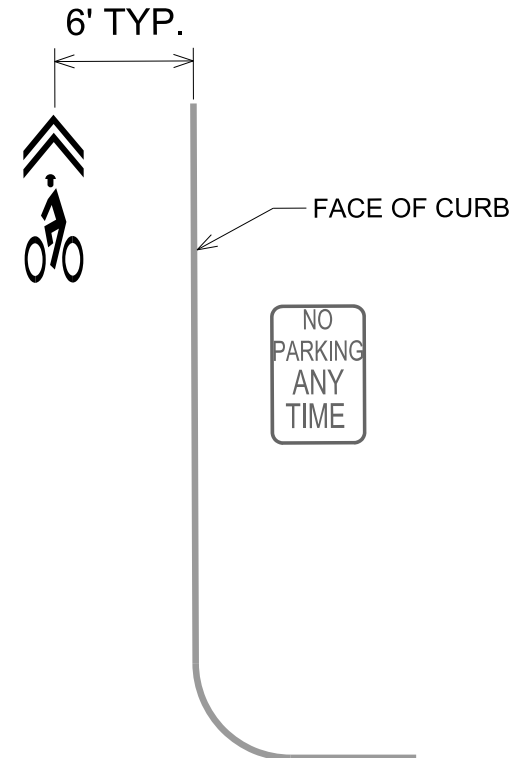

Sharrow Centerline
NO On Street Parking

St Width (face-face)	Sharrow Placement (from face)
22'	11'
24'	12'
>= 26'	13'

D - 8

CITY OF MADISON
ENGINEERING DIVISION

PAVEMENT MARKINGS
SHARROW BIKE DETAILS
PAGE 4b

STANDARD DETAIL DRAWING # 6.40

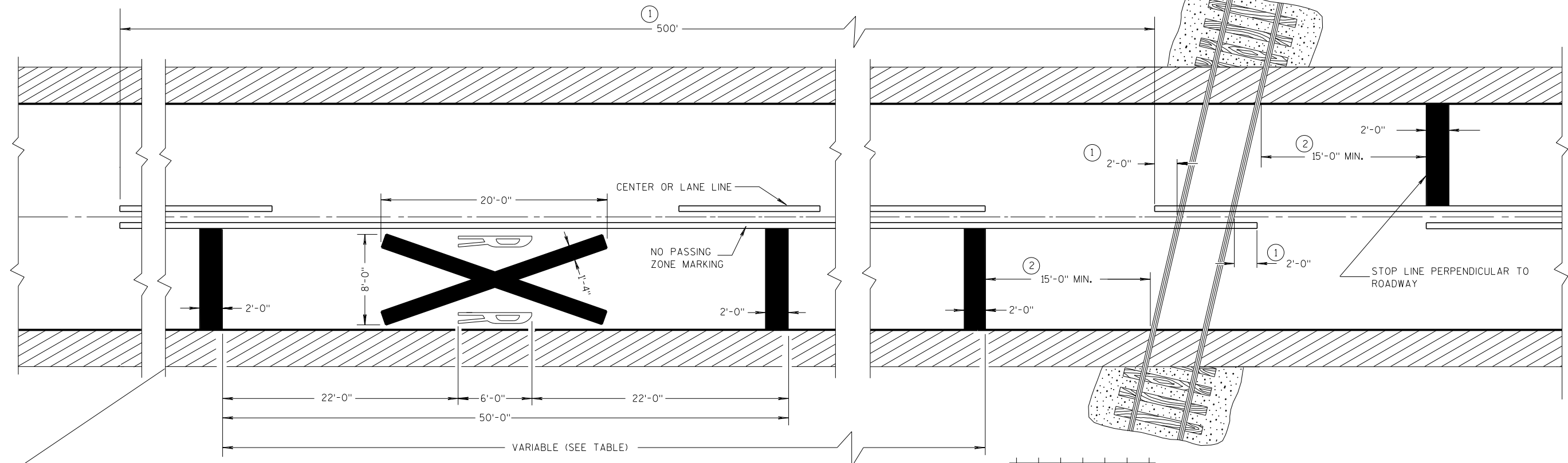

ALTERNATE PAVEMENT MARKING

MATCH LINE

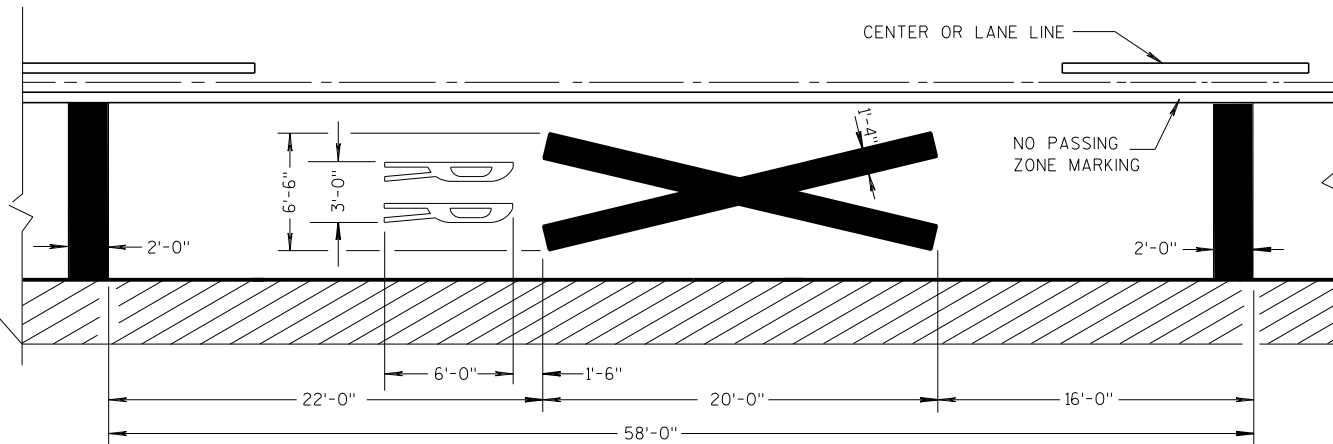

PREFERRED PAVEMENT MARKING

Posted Speed (M.P.H.)	Variable Dimension (Feet)
25	150
30	200
35	250
40	300
45	400
50	550
55	750

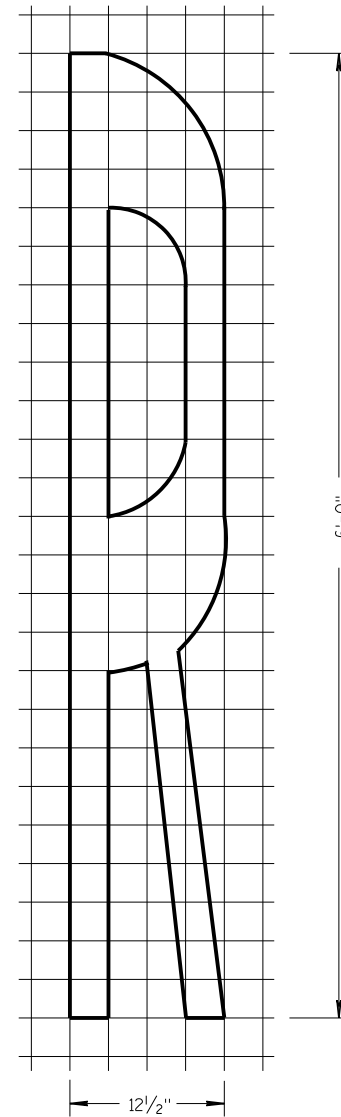

GENERAL NOTES

DETAILS OF CONSTRUCTION, MATERIALS, AND WORKMANSHIP NOT SHOWN ON THIS DRAWING SHALL CONFORM TO THE PERTINENT REQUIREMENTS OF THE STANDARD SPECIFICATIONS AND THE APPLICABLE SPECIAL PROVISIONS.

THE DISTANCE FROM THE RAILROAD CROSSING MARKING TO THE NEAREST TRACK WILL VARY ACCORDING TO THE APPROACH SPEED AND THE SIGHT DISTANCE OF THE VEHICULAR TRAFFIC. DIMENSIONS SHOWN IN THE TABLE SHALL BE USED UNLESS OTHERWISE SHOWN ON THE PLANS.

A THREE-LANE ROADWAY SHOULD BE MARKED WITH A CENTERLINE FOR TWO-LANE APPROACH OPERATION ON THE APPROACH TO A CROSSING.

ON MULTI-LANE ROADS THE TRANSVERSE BANDS SHOULD EXTEND ACROSS ALL APPROACH LANES, AND INDIVIDUAL R X R SYMBOLS SHOULD BE USED IN EACH APPROACH LANE. ALL LETTERS AND SYMBOLS SHALL BE IN CONFORMANCE WITH THE "STANDARD ALPHABETS FOR HIGHWAY SIGNS AND PAVEMENT MARKINGS" (ADOPTED BY THE FEDERAL HIGHWAY ADMINISTRATION).

TRANSVERSE BANDS AND R X R SYMBOL ARE REFLECTIVE WHITE. SOLID LONGITUDINAL LINE IS REFLECTIVE YELLOW ON BIDIRECTIONAL TRAVELED WAYS AND IS OMITTED ON UNIDIRECTIONAL TRAVELED WAYS. DASHED LONGITUDINAL LINE IS REFLECTIVE YELLOW WHEN IT IS BETWEEN LANES OF TRAFFIC MOVING IN OPPOSITE DIRECTIONS AND REFLECTIVE WHITE WHEN IT IS BETWEEN LANES OF TRAFFIC MOVING IN THE SAME DIRECTION.

CENTER OR LANE LINES AND NO PASSING ZONE MARKINGS SHOWN ON THIS DRAWING ARE REQUIRED AND PAID FOR UNDER OTHER ITEMS IN THE CONTRACT.

- ① MARKING LIMITS MAY BE EXTENDED AS DIRECTED BY THE ENGINEER TO MEET ADJACENT NO PASSING ZONE MARKINGS.
- ② MINIMUM 8' TO GATE IF PRESENT.

PAVEMENT MARKING DETAILS FOR RAILROAD-HIGHWAY GRADE CROSSINGS

STATE OF WISCONSIN
DEPARTMENT OF TRANSPORTATION

APPROVED
11/29/00
DATE

FHWA

DETAIL DRAWING # 6.40A